

STATION MONITOR

SM-230

SERVICE MANUAL

KENWOOD

©1989-9 PRINTED IN JAPAN
B51-8027-00(T)899

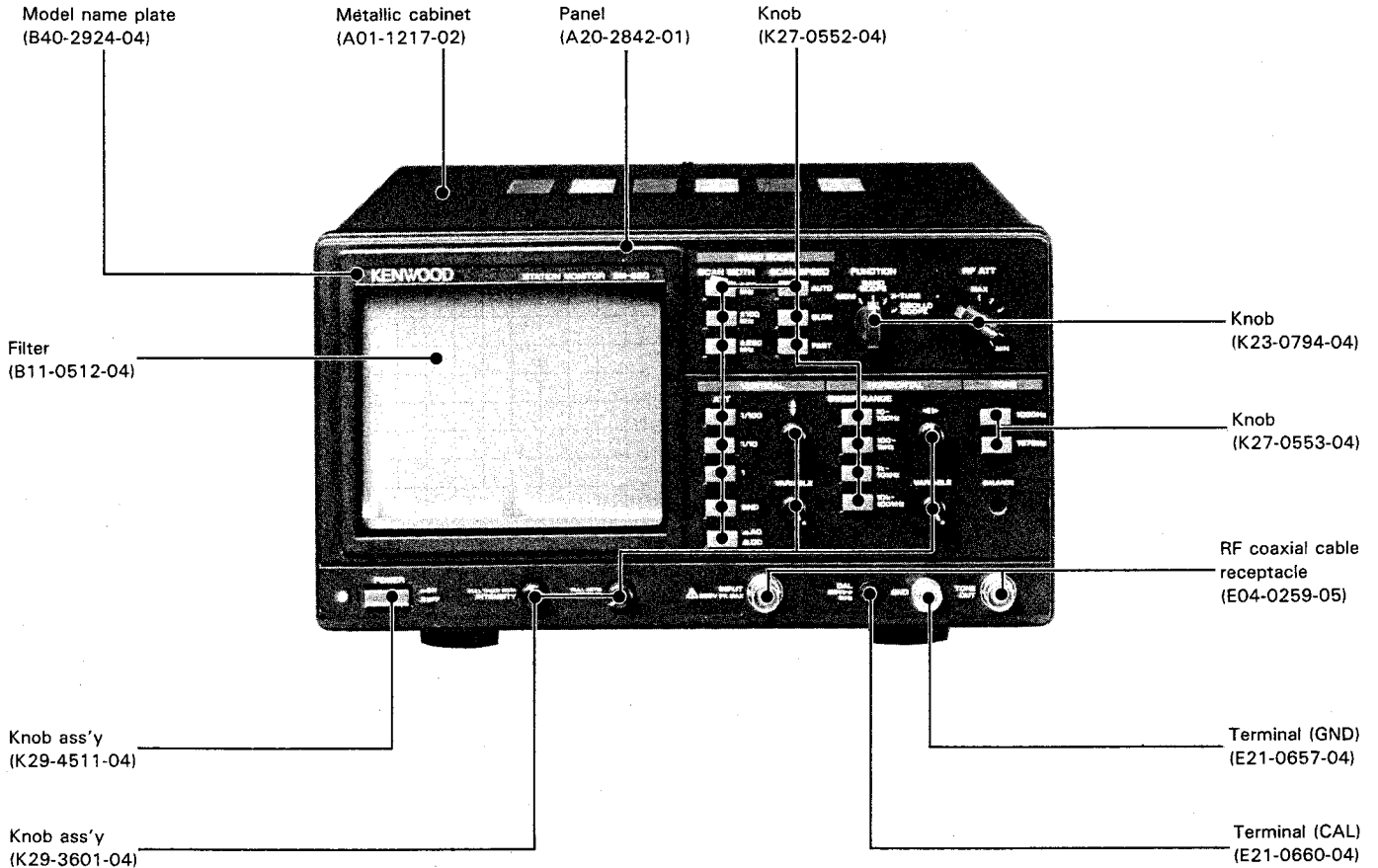

CONTENTS

CIRCUIT DESCRIPTION	2
PARTS LIST	6
EXPLODED VIEW	15
PACKING	17
ADJUSTMENT	18
PC BOARD VIEW	
PANEL UNIT (X69-1160-00).....	23
FILTER UNIT (X70-1140-00).....	25
VERTICAL UNIT (X73-1870-00).....	27
HORIZONTAL UNIT (X74-1510-00)	29

SCHMATIC DIAGRAM.....	31
BLOCK DIAGRAM	37
SPECIFICATIONS.....	Back cover

SM-230

CIRCUIT DESCRIPTION

• Oscilloscope input circuit and preamplifier (X57-1870-00)

When the unit is used as an oscilloscope, the input signal applied to the INPUT BNC socket on the panel is input to the vertical power supply unit (X73-1870-00). The signal passes through the input signal ground circuit, consisting of an AC-DC switching circuit with relays K1 and K2, and is input to the attenuation circuit.

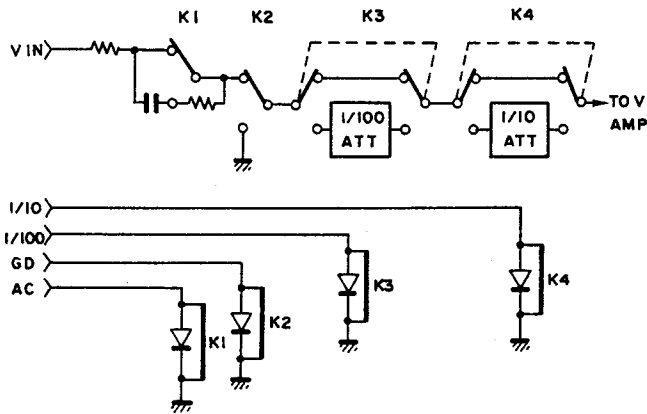

Figure 1

The attenuation circuit has two attenuators connected in series, each with two attenuation ratios. The first attenuator switches between 1/1 and 1/100, and supplies -10 V to the relay only when the ratio is 1/100. The second attenuator switches between 1/1 and 1/10, and supplies -10 V to the relay only when the ratio is 1/10.

After the signal has passed through the attenuation circuit, it is applied to the source follower of U1a. U1 is a constant current load source follower with a dual FET to reduce the DC offset and temperature drift. Q1 is connected to a diode to protect against large negative amplitudes. The signal output from the source follower is attenuated by the vertical potentiometer on the panel and input to the preamplifier, consisting of Q2, Q3, Q5, and U2b, where Q2 is an emitter follower. The high frequency component is amplified by Q3 and the low frequency component is amplified by U2b (feed forward configuration). The signal is output to the final amplifier of the horizontal unit (X74-1510-00) via Q5. U2a used for a band scope, receives signals from the logarithmic amplifier of the horizontal unit. Since relay K2 is forcibly grounded at this time, signals input to the oscilloscope are not transferred to the preamplifier.

• Constant-voltage stabilizing circuit (X73-1870-00)

The stabilizing power supply produces $+5$ V, ± 10 V, and $+140$ V. Each supply consists of an operational amplifier and control transistor. The ± 10 V supply is generated from non-stabilized 13 V, $+140$ V is generated from non-stabilized 170 V, and $+5$ V is generated from non-stabilized $+10$ V. For ± 10 V and $+140$ V, bleeder resistors R101, R107, and R117 are connected in parallel to reduce the power consumption of the control transistors.

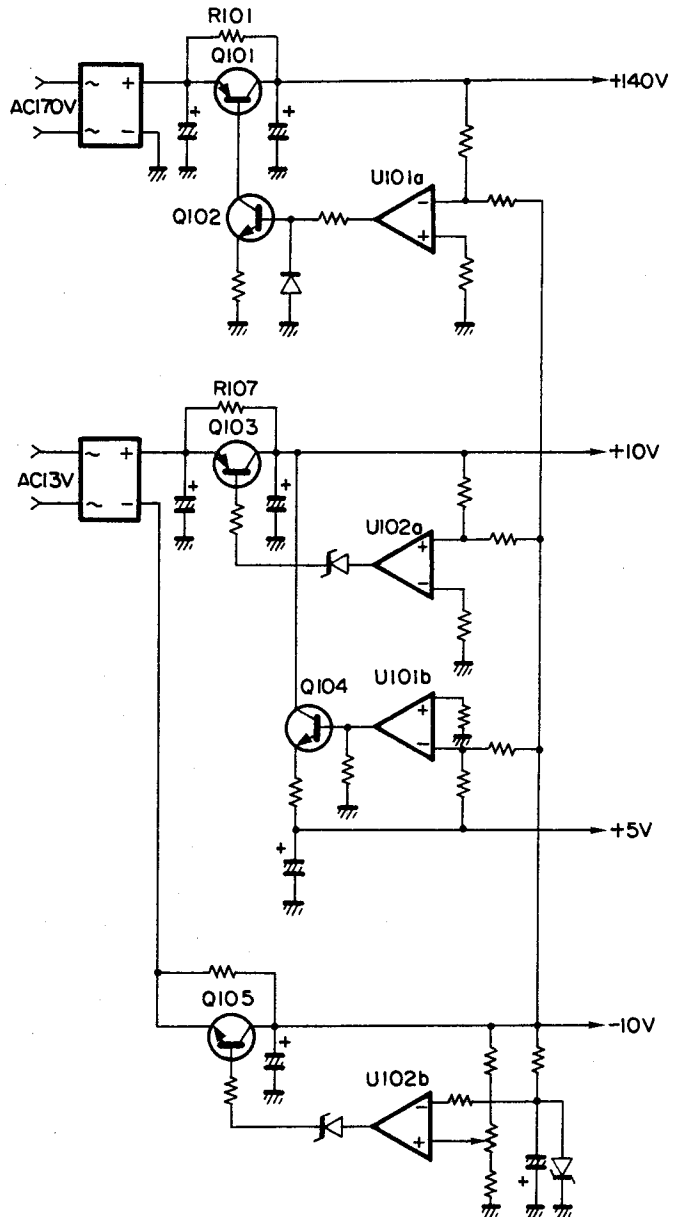

Figure 2

CIRCUIT DESCRIPTION

• High-voltage circuit and blanking (X73-1870-00)

The high-voltage circuit contains an oscillation section consisting of Q153, Q154, and T151, a high voltage generation section consisting of T151 and W151, and a control section consisting of U151b. The negative voltage determined by the ratio of the resistance of R168 and R170 to the resistance of R176 is output to C of W151 for the +10 V supply. W151 is a high-voltage rectification block providing double voltage rectification.

Q151, Q152, and R151 to R162 form a focus circuit. The focus can be adjusted by changing the potential of P1 of the CRT using the focus potentiometer on the panel. The unblanking signal from the sweep gate of the horizontal unit (X74-1510-00) is amplified by Q155, DC-reproduced to the potential based on the CRT cathode potential by C159 to C161, and input to the first grid of the CRT.

Q151, Q152, and R151 to R162 form a focus circuit. The focus can be adjusted by changing the potential of P1 of the CRT using the focus potentiometer on the panel. The unblanking signal from the sweep gate of the horizontal unit (X74-1510-00) is amplified by Q155, DC-reproduced to the potential based on the CRT cathode potential by C159 to C161, and input to the first grid of the CRT.

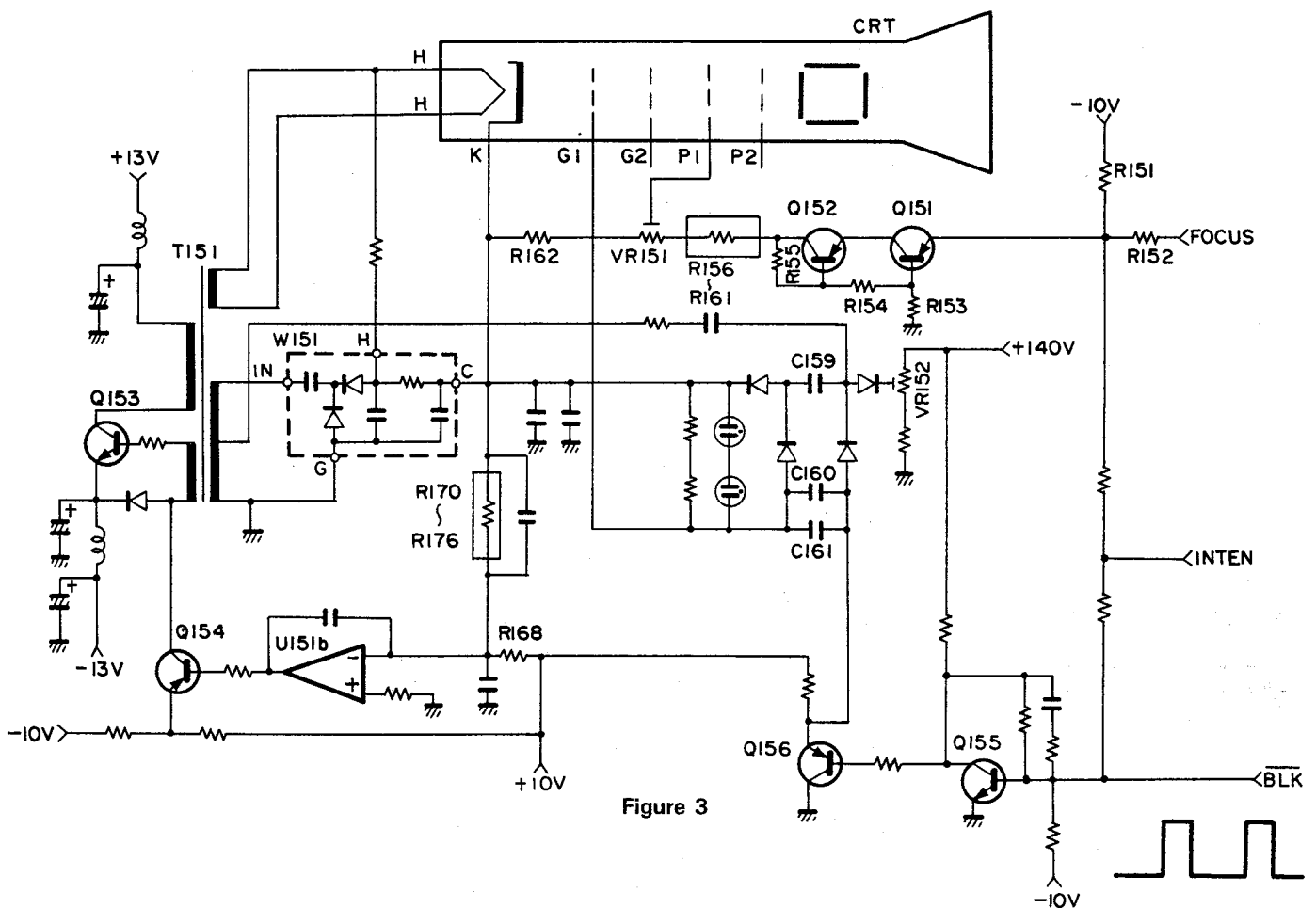

Figure 3

• Vertical final amplifier (X74-1510-00)

The vertical signal of the oscilloscope and band scope is output from the vertical unit, passes through P4, and is input to the base of Q101. Q101 to Q108 have differential configuration, and amplify according to the ratio of resistances between R112 and R113 and the Q101 and Q102 emitters. Q101, Q102, Q105, and Q106 are used for amplification, and Q103 and Q104 are used for impedance conversion.

The output is directed to the $\pm Y$ deflector from P16. In the X-TUNE mode, the SPACE signal selected by the U6b is applied to the base of Q102.

CIRCUIT DESCRIPTION

• Trigger sweep circuit (X74-1510-00)

The trigger signal for the oscilloscope is taken from the preamplifier and applied to the base of Q1. The trigger signal for the monitor is applied to the base of Q3 via the RF input detection circuit. Either the oscilloscope input or the monitor input is selected as a trigger signal by the switching actions of Q2 and Q4. The selected signal passes through Q5 and Q6 and is applied to the clamp amplifier, Q7. The output is rectified by the Schmit circuit, U1a and b, and further applied to flipflop U2a for sweep gate generation and to the auto circuit Q8 and Q9. This sweep gate uses the output (Q) inverted to the sweep start level by the CK input in the trigger wait state, the auto circuit output which detects whether there is a trigger signal, and the sweep end signal and the hold-off end signal as Set and Reset input; output is from U2a.

This output is directed to U1b. For X-TUNE, U1b stops sweeping. The output from U1b is applied to the base of transistors Q10 and Q20 to discharge the sweep capacitor, running and stopping the saw-tooth waves.

The sweep circuit is based on the constant-current system. The reference generated by R33 and R34 is controlled, and

the power supply in the panel unit and the voltage applied to the resistor for the sweep time constant connected to the above emitter are stabilized to supply a constant current to capacitors C7 and C20.

U5a, Q11, and C7 form a circuit that generates saw-tooth waves for the horizontal axis in the oscilloscope mode, and U5b, Q19, and C20 form a circuit that generates saw-tooth waves for the horizontal axis in the bandscope mode. These circuits are switched by U6a.

The saw-tooth wave output is applied to source follower U3 for impedance conversion from the analog switch U6a.

The output from U3 is applied to the horizontal final amplifier, the VCO for frequency sweeping in the bandscope mode, and the sweep end point detection circuit, Q13. The output from Q13 is passed through U2b, and the sweep end signal is sent to U2a. U2b, Q14, and Q15 form a single stable multi-vibrator to use the holdoff signal to assure the down time of the sweep saw-tooth signals. The sweep gate output (U1d) is directed to the vertical unit as an unblanking signal.

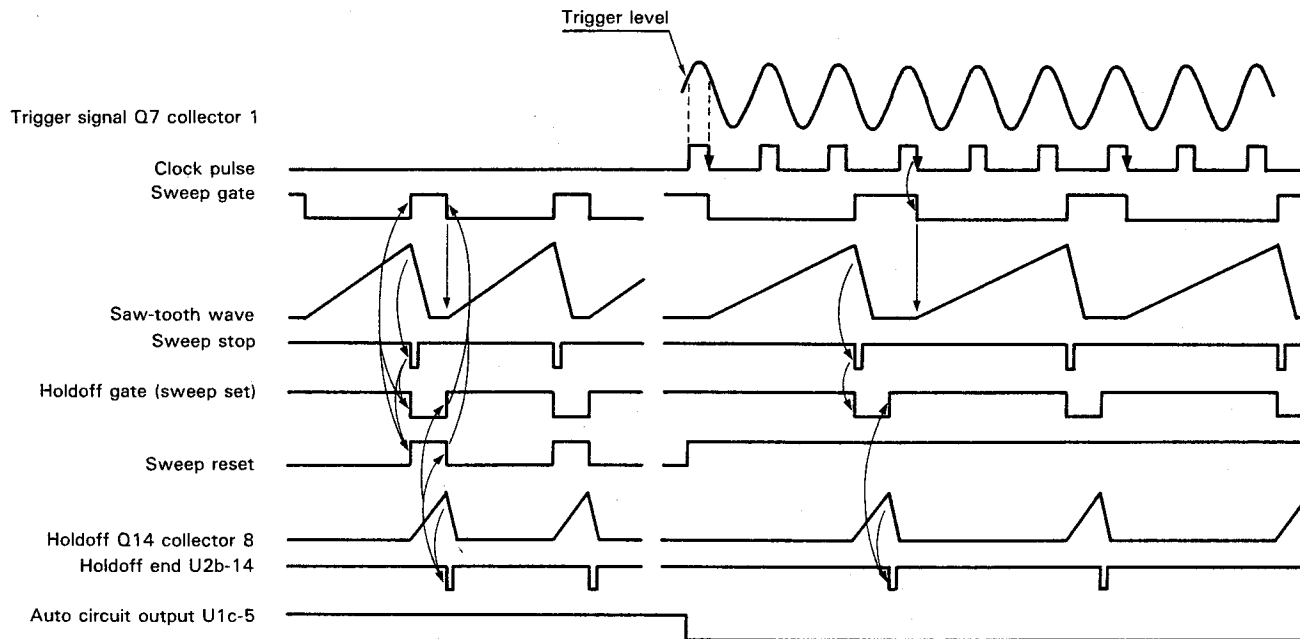

• Horizontal final amplifier (X74-1510-00)

Q16 and Q17 form a differential amplifier circuit. The saw-tooth wave is applied to the base of Q16. In the oscilloscope and bandscope mode, the DC level is applied to the base of Q17 as the horizontal position. In the bandscope mode, Q18 is turned on to suppress the variable amount of the horizontal position. In X-TUNE mode, the MARK signal of the X-TUNE selected by the analog switch U6b is applied to the base of Q17.

• Bandscope VCO (X74-1510-00)

The offset (scan width balance) and gain (scan width) of the saw-tooth wave output from U3 are adjusted by U203a. R204, R205, and R257 are selected by the attenuator for band width selection and analog switching, and the amplitude of the saw-tooth wave is attenuated.

The saw-tooth wave is output as a bias for the varicap diode, U203b. For the oscillation circuit, the oscillation frequency is determined by the varicap diode capacitance, fixed capacity, and coil value.

CIRCUIT DESCRIPTION

● Bandscope mix circuit and logarithmic amplifier (X74-1510-00)

The IF signal of the transmitter is input from P12 and passed through the necessary band (8.83 MHz band) by the tuning coil, T201. This output is applied to G1 of the dual gate FET of Q202, and mixed with the bandscope VCO which is input to G2. Only the 455 kHz component is output. The signal is then passed through the source follower of Q203, logarithmic amplifier Q204 and Q205, emitter follower Q206, and logarithmic amplifier Q207 and Q208.

The signal is passed through the detection diodes D211 and D212 from Q209, and fed to U201a. The output from U201 is ground when the oscilloscope mode is selected by the analog switch. In the bandscope mode, the output from D213 is directed to the vertical power supply unit.

● Intensity marker circuit (X74-1510-00)

The saw-tooth wave output from U3 applied to U202a and U202b with different offsets, and the wind comparator output is obtained. This output is directed to the vertical power supply unit as an unblanking signal.

● X-TUNE amplifier (X74-1510-00)

X-TUNE is applied from the RCA pin on the rear. The MARK signal is passed through the amplifier U302b, converted into a position signal for sweeping by U6b, and applied to the horizontal final amplifier of Q17.

The SPACE signal is passed through the amplifier U302a, converted into a vertical position signal by U6b, and selected and applied to the final unit, Q102.

● TWO-TUNE (X74-1510-00)

A 1000 Hz signal is generated by the Wein bridge oscillator U301b and 1575 Hz is generated by the Wein bridge oscillator U301a.

● CAL circuit (X69-1160-00)

The 1 kHz square wave oscillation circuit contains U1a.

● Panel unit switch and potentiometer (X69-1160-00)

S1 to S3 are scan width selection switches. Signals are output as scan width data by the analog switch U201b of the horizontal unit (X74-1510-00) and the DIN plug from the rear. S4 to S6, S2b, and S3b are scan speed selection switches. Each switch changes the resistance for the sweep time constant, and signals are applied to U5b and Q19 of the horizontal unit. They form a constant-current circuit.

S7 to S9 are attenuators for the oscilloscope mode and are used for switching relays K3 and K4.

S10 is a ground select signal for the oscilloscope mode and is used for relay K2 switching.

S11 is an AC/DC switching signal for the oscilloscope mode and is used for relay K1 switching.

S12 to S15 are sweep speed select switches for the oscilloscope and monitor modes. Each switch selects a resistor, and is applied to U5a and Q11. They form a constant-current circuit. S16 and S17 are on/off switches for 1000 Hz and 1575 Hz TWO-TUNE.

VR1 is a horizontal position potentiometer controlling input to Q102 via the analog switch of the horizontal unit U6b.

VR2 is a vertical potentiometer controlling input to the preamplifier of the vertical power supply unit.

VR3 is a horizontal position potentiometer for signals passed through the horizontal unit U6b and input to Q17.

VR4 is a horizontal potentiometer for signals passed through the buffer of U2a and input to the S12 to S15 switches.

● Monitor circuit

The RF signal is input from the M type plug on the rear, passed through the capacitor and resistor for signal pickup, and input to the rotary switch S1. It is attenuated by the capacitor, input to the CRT as a Y signal, and passed through the detection circuit and input to the trigger input of the horizontal unit.

The RF input has a surge absorber.

PARTS LIST

SEMICONDUCTOR

N: New Parts

Item	Remarks	Parts NO.
Diode		1S1587
		1SR35-200
		1SS83
		1SS132
		1SV50
	N	S1VB20
	N	S1VB60
	N	DSA-102MA MA700
Zener diode		MTZ10JC
		MTZ5.1JB
Thermister		112-102-2
		112-103-2
Transistor	N	2SA1091
	N	2SA1156
		2SA1175
		2SA1206
	N	2SA1207
	N	2SA1209
		2SA684
	N	2SB1133
		2SC1384
	N	2SC2271
	N	2SC2785
	N	2SC2909
	N	2SC3315
	N	2SC3732
	N	2SC3779
		2SD1666
	2SD613	
FET	N	2SK332
		2SK389
	N	2SK404
		3SK73
IC		NJM072BS
		NJM4558D
		SN74LS112AN
		SN74LSOON
	N	TC082CP
		TC4053BP

PARTS LIST

× New Parts

Parts without Parts No. are not supplied.

Les articles non mentionnes dans le Parts No. ne sont pas fournis.

Telle ohne Parts No. werden nicht geliefert.

Ref. No.	Address	New Parts	Parts No.	Description	Destination	Remarks
参照番号	位置	新	部品番号	部品名 / 規格	仕向	備考
SM-230						
1	1B	*	A01-1217-02	METALLIC CABINET		
2	2A	*	A20-2842-01	PANEL		
		*	B42-3684-04	LABEL (S/N0)	K	
		*	B42-3685-04	LABEL (S/N0)	MW	
3	2A	*	B11-0512-04	FILTER		
4	2A	*	B40-2924-04	MODEL NAME PLATE		
-			B46-0410-20	WARRANTY CARD	K	
-			B46-0419-00	WARRANTY CARD	W	
-		*	B50-7706-00	INSTRUCTION MANUAL		
C1		*	CC45SL3D120J	CERAMIC 12PF J		
C2			CC45CH2H050C	CERAMIC 5.0PF C		
C3			CC45CH2H030C	CERAMIC 3.0PF C		
C4			CC45CH2H010C	CERAMIC 1.0PF C		
5	1D	*	D21-0924-04	EXTENSION SHAFT		
6	2D	*	D21-0925-03	EXTENSION SHAFT		
7	2D		D22-0402-05	JOINT		
		*	E23-0513-05	TERMINAL(M TYPE RESEPTACLE GND		
		*	E23-0577-04	TERMINAL		
			E30-0545-05	AC POWER CORD	M	
			E30-0974-05	AC POWER CORD	K	
		*	E30-1815-05	AC POWER CORD	W	
		*	E30-1851-05	AC POWER CORD	M	
		*	E30-1852-05	AC POWER CORD	W	
		*	E30-1889-05	CORD (IF INPUT)		
		*	E30-1890-05	CORD (8PIN DIN)		
		*	E30-1891-05	CORD (X-TUNE)		
		*	E30-1892-05	CORD (TWO-TONE)		
		*	E30-1893-05	AC POWER CORD	K	
		*	E31-5707-05	CONNECTING WIRE(P1)		
		*	E31-5708-05	CONNECTING WIRE(P11)		
		*	E31-5709-05	CONNECTING WIRE(P12-14)		
		*	E31-5710-05	CONNECTING WIRE(P15)		
		*	E31-5711-05	CONNECTING WIRE(P16)		
		*	E31-5712-05	CONNECTING WIRE(P18)		
		*	E31-5713-05	CONNECTING WIRE(JW102-105)		
		*	E31-5715-05	CONNECTING WIRE(JW101)		
		*	E31-5717-05	CONNECTING WIRE		
		*	E31-5718-05	CONNECTING WIRE		
8	1F		E04-0167-05	RF COAXIAL CABLE RECEPTACLE		
9	2A	*	E04-0259-05	RF COAXIAL CABLE RECEPTACLE		
10	2A	*	E21-0657-04	TERMINAL (GND)		
11	2A	*	E21-0660-04	TERMINAL (CAL)		
P21		*	E31-2369-05	CONNECTING WIRE	K	
P21		*	E31-2370-05	CONNECTING WIRE	MW	
		*	F05-3011-05	FUSE (0.3A)	MW	
		*	F05-4018-05	FUSE (0.4A)	K	
		*	F10-1615-04	SHIELDING PLATE		
		*	F15-0733-04	FELT		
		*	F15-0754-04	FELT		
12	1C	*	F11-1226-03	SHIELDING COVER		
13	1B	*	F11-1227-03	SHIELDING COVER		

E: Scandinavia & Europe K: USA P: Canada W: Europe

U: PX(Far East, Hawaii) T: England M: Other Areas

UE: AAFES(Europe) X: Australia

 indicates safety critical components.

SM-230

PARTS LIST

× New Parts

Parts without Parts No. are not supplied.

Les articles non mentionnes dans le Parts No. ne sont pas fournis.

Teile ohne Parts No. werden nicht geliefert.

Ref. No. 参照番号	Address 位置	New Parts 新	Parts No. 部品番号	Description 部品名 / 規格	Desti- nation 仕 向	Re- marks 備考
14	1B	*	F11-1228-03	SHIELDING COVER		
C			G09-0405-05	SPRING		
-		*	H09-0502-04	PACKING CASE(OTHERS)		
-		*	H01-5911-04	ITEM CARTON BOX		
-		*	H03-1872-04	OUTER PACKING CASE		
-		*	H10-2903-02	POLYSTYRENE FOAMED FIXTURE(F)		
-		*	H10-2904-02	POLYSTYRENE FOAMED FIXTURE(R)		
-		*	H20-1731-04	PROTECTION COVER		
			J02-0089-05	FOOT (REAR)		
			J19-1313-05	LEAD HOLDER	KM	
		*	J19-1653-23	CRT HOLDER		
			J42-0021-05	POWER CORD BUSHING	M	
			J42-0083-05	POWER CORD BUSHING		
			J42-0085-05	POWER CORD BUSHING	KW	
15	2E		J02-0423-04	FOOT		
16	2E		J02-0424-04	FOOT		
-			J61-0038-05	WIRE BAND	K	
-			J61-0408-05	WIRE BAND		
-		*	J61-0520-05	WIRE BAND		
-		*	J61-0531-05	WIRE BAND		
A	2A		K29-4511-04	KNOB ASSY		
B	2A		K23-0794-04	KNOB		
C	2A		K29-3061-04	KNOB ASSY		
D	2A	*	K27-0553-04	KNOB		
E	2A	*	K27-0552-04	KNOB		
17	1F	*	L01-9866-05	POWER TRANSFORMER		
18	1C	*	L39-0526-25	ROTATE COIL		
			N10-2030-41	HEXAGON NUT	W	
F	2C		N09-0623-04	SCREW (M3X8)		
G	2E		N09-0626-04	SCREW (M3X10)		
H	1E		N09-0654-05	SCREW (M4X8)		
I	2B, 2E	*	N09-0739-05	SCREW (M3X8)		
J	1C	*	N09-0748-04	SCREW (M3X12)		
K	1A, 1B	*	N09-0768-05	SCREW (M3X8)		
L	2B		N10-2040-41	HEXAGON NUT		
M	2A	*	N14-0602-34	NUT		
N	1F	*	N14-0604-05	NUT		
O			N15-1040-41	FLAT WASHER		
P			N16-0040-41	SPRING WASHER		
Q			N30-2608-41	PAN HEAD MACHINE SCREW		
R	1E		N30-4010-41	PAN HEAD MACHINE SCREW		
S	1E		N30-4014-41	PAN HEAD MACHINE SCREW		
T	2A		N33-3008-41	OVAL HEAD MACHINE SCREW		
U	1F		N89-3008-41	BINDING HEAD TAPTITE SCREW		
R1 , 2			RD14BY2H105J	RD 1.0M J 1/2W		
		*	S01-2515-05	ROTARY SWITCH (RF ATT)		
		*	S01-4504-05	ROTARY SWITCH (FUNCTION)		
19	1B	*	150GTM31A	CRT		
			W01-0406-14	ADJ.TOOL		
			W03-2309-05	OSCILLO CARD (ACCY)		

E: Scandinavia & Europe K: USA P: Canada W: Europe

U: PX(Far East, Hawaii) T: England M: Other Areas

UE: AAFES(Europe) X: Australia

▲ indicates safety critical components.

PARTS LIST

× New Parts

Parts without Parts No. are not supplied.

Les articles non mentionnés dans le Parts No. ne sont pas fournis.

Teile ohne Parts No. werden nicht geliefert.

Ref. No. 参照番号	Address 位置	New Parts 新	Parts No. 部品番号	Description 部品名 / 規格	Desti- nation 仕 向	Re- marks 備考
20	2B	*	X69-1160-00	PANEL UNIT		
21	1D	*	X70-1140-00	FILTER UNIT		
22	2E	*	X73-1870-00	VERTICAL AMP UNIT		
23	2F	*	X74-1510-00	HORIZONTAL AMP UNIT		
PANEL UNIT (X69-1160-00)						
C6			CK45FF1H103Z	CERAMIC 0.010UF Z		
C7		*	C91-1308-05	FIXED CAPACITOR 0.01UF		
C1-5			CE04CW1C220M	ELECTRO 22UF 16WV		
C101		*	CC45SL3D120J	CERAMIC 12PF J		
C102			CC45FSL1H561J	CERAMIC 560PF J		
C103		*	CK45B2H103K	CERAMIC 0.010UF K		
C104		*	CK45FB2H222K	CERAMIC 2200PF K		
			E40-3237-05	PIN CONNECTOR (2P)		
JW3		*	E31-5704-05	CONNECTING WIRE(VARI.)		
JW9		*	E31-5705-05	CONNECTING WIRE		
JW10		*	E31-5716-05	CONNECTING WIRE		
JW22		*	E31-5703-05	CONNECTING WIRE(CAL.)		
JW101-105			E23-0512-05	TERMINAL		
R10		*	R90-0658-05	MULTI-COMP		
R101		*	R92-1420-05	FIXED RESISTOR 510 7W		
R102			RS14AB3D103J	FL-PROOF RS 10K J 2W		
VR1		*	R05-3521-05	POTENTIOMETER (20K-B)		
VR2		*	R05-0503-05	POTENTIOMETER (500-B)		
VR3 ,4		*	R05-3521-05	POTENTIOMETER (20K-B)		
VR5		*	R12-3561-05	TRIMMING POT. (47K-B)		
S1 -9		*	S42-3516-05	PUSH SWITCH		
S10 ,11		*	S42-1502-05	PUSH SWITCH		
S12 -15		*	S42-4515-05	PUSH SWITCH		
S16 ,17		*	S42-1502-05	PUSH SWITCH		
D1 ,2			1SS132	DIODE		
D101		*	DSA-102MA	SERGE ABSORBER		
D102,103			MA700	DIODE		
D104			1S1587	DIODE		
U1			NJM4558D	IC(OP AMP X2)		
U2			NJM072BS	IC(OP AMP X2)		
FILTER UNIT (X70-1140-00)						
C1		*	C91-0551-05	FIXED CAPACITOR 0.22UF 630V		
C3 ,3		*	C91-0575-05	FIXED CAPACITOR 1000PF 4KV		
C301,302			CQ92M1H104K	MYLAR 0.10UF K		
		*	E01-0103-05	CRT SOCKET		
		*	E06-0862-05	CYLINDRICAL RECEPTACLE		
		*	E13-0871-05	PHONE JACK		
JW2A, B		*	E31-5701-05	CONNECTING WIRE		
		*	E31-5699-05	CONNECTING WIRE		
JW6A, B		*	E31-5700-05	CONNECTING WIRE		
P12 -14			E40-5067-05	PIN CONNECTOR (10PIN)		
P18			E40-3300-05	PIN CONNECTOR (3PIN)		
P19 ,20		*	E40-0803-05	PIN CONNECTOR (8PIN)		
P21		*	E40-7021-05	PIN CONNECTOR (3PIN)		
		*	J13-0512-05	FUSE HOLDER		
L1		*	L33-0808-05	CHOKE COIL		

E: Scandinavia & Europe K: USA P: Canada W: Europe

U: PX(Far East, Hawaii) T: England M: Other Areas

UE: AAFES(Europe) X: Australia

 indicates safety critical components.

PARTS LIST

× New Parts

Parts without Parts No. are not supplied.

Les articles non mentionnés dans le Parts No. ne sont pas fournis.

Telle ohne Parts No. werden nicht geliefert.

Ref. No. 参照番号	Address 位置	New Parts 新	Parts No. 部品番号	Description 部品名 / 規格	Desti- nation 仕向	Re- marks 備考
R301 VR201 VR202		*	R92-1061-05	JUMPER REST 0 0HM		
		*	R23-0501-05	POTENTIOMETER (FOCUS, ASTIG)		
		*	R23-3504-05	POTENTIOMETER (INT, ROT.)		
S1		*	S40-1529-05	PUSH SWITCH (POWER)		
			LN222RP	LED		
VERTICAL AMP UNIT (X73-1870-00)						
		*	B41-0710-04	CAUTION LABEL		
C1		*	C91-0501-05	MF 0.047UF 630V		
C2			CC45FSL1H221J	CERAMIC 220PF J		
C3			CC45FCH1H330J	CERAMIC 33PF J		
C4			CK45FB2H102K	CERAMIC 1000PF K		
C6			CC45FSL1H391J	CERAMIC 390PF J		
C7			CC45FCH1H050C	CERAMIC 5.0PF C		
C8 , 9			CC45FCH1H220J	CERAMIC 22PF J		
C10			CE04EW1A331M	ELECTRO 330UF 10WV		
C11		*	CQ92FM1H104K	MYLAR 0.10UF K		
C12		*	C91-1276-05	FIXED CAPACITOR		
C16			CC45FCH1H101J	CERAMIC 100PF J		
C18		*	CC45FCH1H200J	CERAMIC 20PF J		
C19			CC45FCH1H100D	CERAMIC 10PF D		
C101		*	CE04W2E101M	ELECTRO 100UF 250WV		
C102		*	CE04W2C3R3M	ELECTRO 3.3UF 160WV		
C103		*	CE04EW1E222M	ELECTRO 2200UF 25WV		
C104			CE04EW1C471M	ELECTRO 470UF 16WV		
C105			CE04EW1A221M	ELECTRO 220UF 10WV		
C106		*	CE04EW1E222M	ELECTRO 2200UF 25WV		
C107			CE04EW1C471M	ELECTRO 470UF 16WV		
C108		*	CE04EW1A330M	ELECTRO 33UF 10WV		
C109, 110			CE04EW1E221M	ELECTRO 220UF 25WV		
C112, 113		*	CQ92FM1H104K	MYLAR 0.10UF K		
C117, 118		*	CQ92FM1H104K	MYLAR 0.10UF K		
C120-124		*	CK45FF1H103Z	CERAMIC 0.010UF Z		
C127		*	CK45FB2H472K	CERAMIC 4700PF K		
C130			CK45FF1H103Z	CERAMIC 0.010UF Z		
C140			CK45FF1H103Z	CERAMIC 0.010UF Z		
C141, 142		*	CK45FB2H472K	CERAMIC 4700PF K		
C143-147			CK45FF1H103Z	CERAMIC 0.010UF Z		
C151, 152		*	CK45FB2H472K	CERAMIC 4700PF K		
C153, 154			CE04EW1E221M	ELECTRO 220UF 25WV		
C155			CC45FSL1H471J	CERAMIC 470PF J		
C156		*	CK45E3D102P	CERAMIC 1000PF P		
C157-161		*	C91-0571-05	CERAMIC 0.01UF 2KV		
C162		*	CE04W2C010M	ELECTRO 1.0UF 160WV		
C164			CK45FB2H102K	CERAMIC 1000PF K		
C166			CK45FB1H472K	CERAMIC 4700PF K		
TC1		*	C05-0066-05	TRIMMING CAP (10PF)		
TC2			C05-0065-05	TRIMMING CAP (6PF)		
TC3		*	C05-0066-05	TRIMMING CAP (10PF)		
TC4			C05-0065-05	TRIMMING CAP (6PF)		
TC5		*	C05-0445-05	TRIMMING CAP (20PF)		
P1			E40-3237-05	PIN CONNECTOR (2PIN)		
P2			E40-3243-05	PIN CONNECTOR (8PIN)		

E: Scandinavia & Europe K: USA P: Canada W: Europe

U: PX(Far East, Hawaii) T: England M: Other Areas

UE: AAFES(Europe) X: Australia

 indicates safety critical components.

PARTS LIST

× New Parts

Parts without Parts No. are not supplied.

Les articles non mentionnés dans le Parts No. ne sont pas fournis.

Telle ohne Parts No. werden nicht geliefert.

Ref. No. 参照番号	Address 位置	New Parts 新	Parts No. 部品番号	Description 部品名 / 規格	Desti- nation 仕 向	Re- marks 備考
P3			E40-3238-05	PIN CONNECTOR (3PIN)		
P4		*	E40-0416-05	PIN CONNECTOR (4PIN)		
P5			E40-0716-05	PIN CONNECTOR (7PIN)		
P6		*	E40-7016-05	PIN CONNECTOR (8PIN)		
P7			E40-0273-05	PIN CONNECTOR (2PIN)		
P8 ,9			E40-3242-05	PIN CONNECTOR (7PIN)		
			F01-0813-05	HEAT SINK		
		*	F11-1229-04	SHIELDING COVER		
		*	F11-1230-03	SHIELDING COVER		
		*	F15-0727-04	SHADE (FOR NL1,2)		
		*	F20-0687-04	INSULATING BOARD		
L151,152 T151			L40-1011-04	SMALL FIXED INDUCTOR		
		*	L19-0413-05	CONV. TRANSFORMER		
			N30-2606-41	PAN HEAD MACHINE SCREW		
			N30-3008-41	PAN HEAD MACHINE SCREW		
R101		*	R92-1411-05	SRP RESISTOR 1.2K 5W		
R107		*	R92-1442-05	SRP RESISTOR 47 1W		
R117		*	R92-1442-05	SRP RESISTOR 47 1W		
R180		*	R92-1443-05	SRP RESISTOR 27 1W		
VR1		*	R12-0502-05	TRIMMING POT. 100-B		
VR2		*	R12-2522-05	TRIMMING POT. 5K-B		
VR101		*	R12-1546-05	TRIMMING POT. 2K-B		
VR151		*	R12-8501-05	TRIMMING POT. 2.2M-B		
VR152		*	R12-5530-05	TRIMMING POT. 100K-B		
K1 ,2		*	S51-1526-05	RELAY		
K3 ,4		*	S51-2510-05	RELAY		
D1 -4			1SS132	DIODE		
D5			MTZ5.1JB	ZENER DIODE		
D101		*	S1VB60	DIODE		
D102			1SS132	DIODE		
D103		*	S1VB20	DIODE		
D104,105			MTZ10JC	ZENER DIODE		
D106			MTZ5.1JB	ZENER DIODE		
D151			1SS132	DIODE		
D152,153			1SR35-200	DIODE		
D154,155			1SS83	DIODE		
NL1 ,2		*	NE-2B	NEON LAMP		
Q1		*	2SC3315(C)	TRANSISTOR		
Q2		*	2SC2785(F)	TRANSISTOR		
Q3		*	2SC3779(D)	TRANSISTOR		
Q5		*	2SC3315(C)	TRANSISTOR		
Q101			2SA1156(K,L)	TRANSISTOR		
Q102		*	2SC2271(D)	TRANSISTOR		
Q103		*	2SB1133(S)	TRANSISTOR		
Q104		*	2SC2785(F)	TRANSISTOR		
Q105		*	2SD1666(S)	TRANSISTOR		
Q151,152		*	2SA1091(O)	TRANSISTOR		
Q153		*	2SD613(E)	TRANSISTOR		
Q154		*	2SA1175(F)	TRANSISTOR		
Q155		*	2SC2909(S)	TRANSISTOR		
Q156		*	2SC1384(R)	TRANSISTOR		
Q157			2SA684	TRANSISTOR		

E: Scandinavia & Europe K: USA P: Canada W: Europe

U: PX(Far East, Hawaii) T: England M: Other Areas

UE: AAFES(Europe) X: Australia

△ indicates safety critical components.

PARTS LIST

* New Parts

Parts without Parts No. are not supplied.

Les articles non mentionnés dans le Parts No. ne sont pas fournis.

Teile ohne Parts No. werden nicht geliefert.

Ref. No. 参照番号	Address 位置	New Parts 新	Parts No. 部品番号	Description 部品名 / 規格	Desti- nation 仕向	Re- marks 備考
Q158		*	2SA1207	TRANSISTOR		
TH1			112-103-2	THERMISTOR		
U1		*	2SK389(GR)	FET		
U2			NJM4558D	IC(OP AMP X2)		
U101,102			NJM4558D	IC(OP AMP X2)		
U151			NJM4558D	IC(OP AMP X2)		
W151		*	W02-0409-05	HIGH VOLTAGE BLOCK		
HORIZONTAL AMP UNIT (X74-1510-00)						
C1		*	CQ92FM1H104K	MYLAR 0.10UF K		
C2			CE04EW1C100M	ELECTRO 10UF 16WV		
C3			CE04EW1A101M	ELECTRO 100UF 10WV		
C4			CQ92FM1H103K	MYLAR 0.010UF K		
C5			CC45CH1H470J	CERAMIC 47PF J		
C6			CE04EW1C100M	ELECTRO 10UF 16WV		
C7		*	C91-0573-05	FIXED CAPACITOR		
C8			CE04BW1H010M	NP-ELEC 1.0UF 50WV		
C9		*	CQ92FM1H102K	MYLAR 1000PF K		
C10			CC45PSL1H331J	CERAMIC 330PF J		
C11,12		*	CQ92FM1H104K	MYLAR 0.10UF K		
C13			CE04EW1A221M	ELECTRO 220UF 10WV		
C14,15			CE04EW1C101M	ELECTRO 100UF 16WV		
C16		*	CE04W2C100M	ELECTRO 10UF 160WV		
C17			CK45B2H472K	CERAMIC 4700PF K		
C18,19			CQ92FM1H103K	MYLAR 0.010UF K		
C20			CF92V1H105J	MF 1.0UF J		
C21-23		*	CQ92FM1H104K	MYLAR 0.10UF K		
C24			CQ92FM1H103K	MYLAR 0.010UF K		
C25			CQ92FM1H222K	MYLAR 2200PF K		
C26			CQ92FM1H103K	MYLAR 0.010UF K		
C27		*	CQ92FM1H104K	MYLAR 0.10UF K		
C28			CC45FCH1H050C	CERAMIC 5.0PF C		
C29			CK45B2H472K	CERAMIC 4700PF K		
C30			CC45CH1H200J	CERAMIC 20PF J		
C50			CC45FSL1H181J	CERAMIC 180PF J		
C101			CC45CH1H101J	CERAMIC 100PF J		
C102			CC45FCH1H050C	CERAMIC 5.0PF C		
C103,104			CF93AN2E103K	MF 0.010UF K		
C105,106		*	CF93AN2E104K	MF 0.10UF K		
C107			CE04EW1A470M	ELECTRO 47UF 10WV		
C108,109		*	CQ92FM1H104K	MYLAR 0.10UF K		
C110			CC45FSL1H151J	CERAMIC 150PF J		
C201,202		*	CQ92FM1H102K	MYLAR 1000PF K		
C203			CC45FCH1H330J	CERAMIC 33PF J		
C204			CC45CH1H220J	CERAMIC 22PF J		
C205			CC45CH1H330J	CERAMIC 33PF J		
C206			CC45CH1H101J	CERAMIC 100PF J		
C207			CC45CH1H050C	CERAMIC 5.0PF C		
C208-220			CQ92FM1H103K	MYLAR 0.010UF K		
C221,222			CQ92M1H104K	MYLAR 0.10UF K		
C223			CE04BW1C221M	ELECTRO 220UF 16WV		
C223		*	CQ92FM1H104K	MYLAR 0.10UF K		
C224			CQ92M1H104K	MYLAR 0.10UF K		
C225			CE04EW1C101M	ELECTRO 100UF 16WV		
C226			CQ92M1H104K	MYLAR 0.10UF K		

E: Scandinavia & Europe K: USA P: Canada W: Europe

U: PX(Far East, Hawaii) T: England M: Other Areas

UE: AAFES(Europe) X: Australia

△ indicates safety critical components.

PARTS LIST

× New Parts

Parts without Parts No. are not supplied.

Les articles non mentionnes dans le Parts No. ne sont pas fournis.

Telle ohne Parts No. werden nicht geliefert.

Ref. No. 参照番号	Address 位置	New Parts 新	Parts No. 部品番号	Description 部品名 / 規格	Desti- nation 仕 向	Re- marks 備考
C228			CE04EW1C470M	ELECTRO 47UF 16WV		
C229		*	CQ92FM1H102K	MYLAR 1000PF K		
C231		*	CQ92FM1H102K	MYLAR 1000PF K		
C301			CE04BW1H010M	NP-ELEC 1.0UF 50WV		
C302, 303			CF92V1H103J	MF 0.010UF J		
C304			CE04BW1H010M	NP-ELEC 1.0UF 50WV		
C305, 306			CF92V1H103J	MF 0.010UF J		
C307			CQ92FM1H222K	MYLAR 2200PF K		
C308			CC45FCH1H100D	CERAMIC 10PF D		
C309			CC45CH1H680J	CERAMIC 68PF J		
TC201		*	C05-0444-05	TRIMMING CAP		
TC202		*	C05-0475-05	TRIMMING CAP		
		*	E31-5706-05	CONNECTING WIRE(B)		
		*	E33-4148-00	FINISHED WIRE SET(A)		
P4			E40-0411-05	PIN CONNECTOR (4P)		
P5			E40-0711-05	PIN CONNECTOR (7P)		
P10			E40-5067-05	PIN CONNECTOR (10P)		
P11			E40-3237-05	PIN CONNECTOR (2P)		
P12			E40-3238-05	PIN CONNECTOR (3P)		
P13, 14			E40-3239-05	PIN CONNECTOR (4P)		
P15			E40-3242-05	PIN CONNECTOR (7P)		
P16			E40-3301-05	PIN CONNECTOR (4P)		
P17			E40-3300-05	PIN CONNECTOR (3P)		
		*	F01-0874-04	HEAT SINK		
		*	F11-1231-04	SHIELDING COVER		
		*	F11-1232-04	SHIELDING COVER		
CF201			L72-0401-05	CERAMIC FILTER		
L101, 102		*	L40-3391-70	SMALL FIXED INDUCTOR		
L201			L33-0801-05	CHOKE COIL		
L202			L40-1021-03	SMALL FIXED INDUCTOR		
L203, 204			L40-2701-03	SMALL FIXED INDUCTOR		
L205		*	L40-1211-70	SMALL FIXED INDUCTOR		
T201			L34-0527-05	COIL (IFT)		
			N30-2606-41	PAN HEAD MACHINE SCREW		
			N30-3008-41	PAN HEAD MACHINE SCREW		
R61, 62		*	R92-1447-05	SPR RESISTOR 22K 2W		
R112, 113		*	R92-1443-05	SPR RESISTOR 27K 1W		
R120, 121		*	R92-1445-05	SPR RESISTOR 1K 1W		
VR1		*	R12-0576-05	TRIMMING POT. 200-B		
VR101		*	R12-2522-05	TRIMMING POT. 5K-B		
VR201		*	R12-5530-05	TRIMMING POT. 100K-B		
VR202		*	R12-3550-05	TRIMMING POT. 20K-B		
VR203			R12-5025-05	TRIMMING POT. 100K-B		
VR301, 302		*	R12-0577-05	TRIMMING POT. 500-B		
VR303			R12-0058-05	TRIMMING POT. 470-B		
VR304			R12-3040-05	TRIMMING POT. 22K-B		
VR305			R12-3042-05	TRIMMING POT. 47K-B		
VR306			R12-3040-05	TRIMMING POT. 22K-B		
VR307		*	R12-5501-05	TRIMMING POT. 150K-B		
D1			1SS132	DIODE		
D2, 3			MTZ10JC	ZENER DIODE		
D4, 5			1SS132	DIODE		

E: Scandinavia & Europe K: USA P: Canada W: Europe

U: PX(Far East, Hawaii) T: England M: Other Areas

UE: AAFES(Europe) X: Australia

 indicates safety critical components.

PARTS LIST

× New Parts

Parts without Parts No. are not supplied.

Les articles non mentionnés dans le Parts No. ne sont pas fournis.

Telle ohne Parts No. werden nicht geliefert.

Ref. No. 参照番号	Address 位置	New Parts 新	Parts No. 部品番号	Description 部品名 / 規格	Desti- nation 仕 向	Re- marks 備考
D8 -11			1SS132	DIODE		
D12 ,13			MA700	DIODE		
D101			1SS132	DIODE		
D201,202			1SV50	DIODE		
D203,204			1SS132	DIODE		
D205,206			MA700	DIODE		
D207-210			1SS132	DIODE		
D211,212			MA700	DIODE		
D213-215			1SS132	DIODE		
D216			MTZ5.1JB	ZENER DIODE		
D217			1SS132	DIODE		
D218			1SS132	DIODE		
D301,302			1SS132	DIODE		
Q1 -4			2SC2785(F)	TRANSISTOR		
Q5			2SA1175(F)	TRANSISTOR		
Q6			2SC2785(F)	TRANSISTOR		
Q7			2SA1206	TRANSISTOR		
Q8			2SA1175(F)	TRANSISTOR		
Q9			2SC2785(F)	TRANSISTOR		
Q10 -20		*	2SC3732(L)	TRANSISTOR		
Q11			2SA1175(F)	TRANSISTOR		
Q12			2SC2785(F)	TRANSISTOR		
Q13 ,14			2SA1175(F)	TRANSISTOR		
Q15			2SC2785(F)	TRANSISTOR		
Q16 ,17		*	2SC2909(S)	TRANSISTOR		
Q18 ,19			2SA1175(F)	TRANSISTOR		
Q21			2SA1175(F)	TRANSISTOR		
Q101-104		*	6SC3315(C)	TRANSISTOR		
Q105,106		*	2SC2911(S)	TRANSISTOR		
Q107,108		*	2SA1209(S)	TRANSISTOR		
Q201			2SK192(GR)	FET		
Q202			3SK73(GR)	FET		
Q203		*	2SK404(F)	FET		
Q204-209			2SC2785(F)	TRANSISTOR		
Q301,302		*	2SK404(F)	FET		
TH301-304			112-102-2	THERMISTOR		
U1			SN74LS00N	IC		
U2			SN74LS112AN	IC		
U3		*	2SK332(F)	FET		
U5			NJM072BS	IC(OP AMP X2)		
U6			TC4053BP	IC(3-INPUT 2CH MPX/DE-MPX)		
U201			TC4053BP	IC(3-INPUT 2CH MPX/DE-MPX)		
U202,203			NJM4558D	IC(OP AMP X2)		
U301			NJM4558D	IC(OP AMP X2)		
U302			TL082CP	IC(OP AMP X2)		

E: Scandinavia & Europe K: USA P: Canada W: Europe

U: PX(Far East, Hawaii) T: England M: Other Areas

UE: AAFES(Europe) X: Australia

△ indicates safety critical components.

EXPLODED VIEW

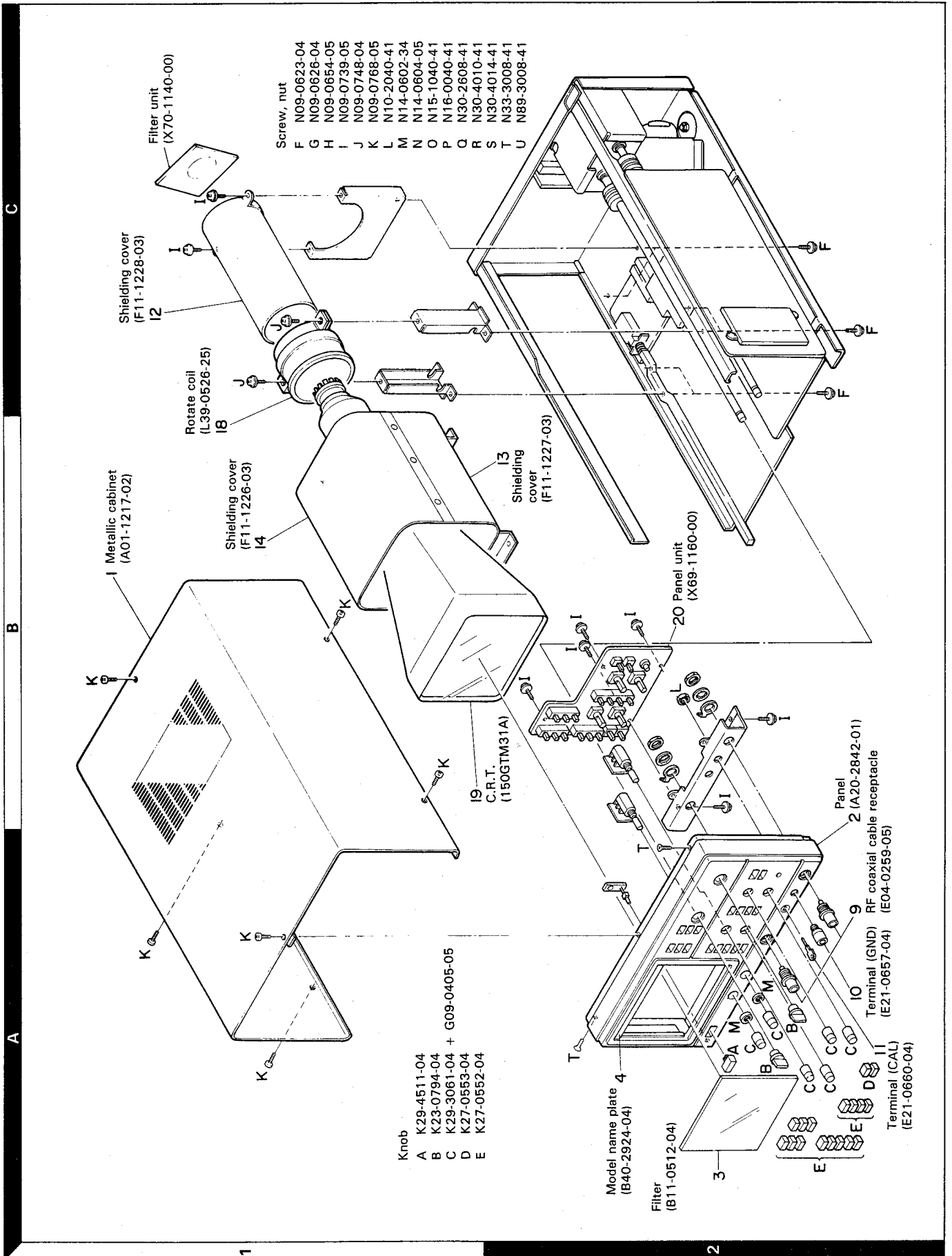

SM-230

EXPLODED VIEW

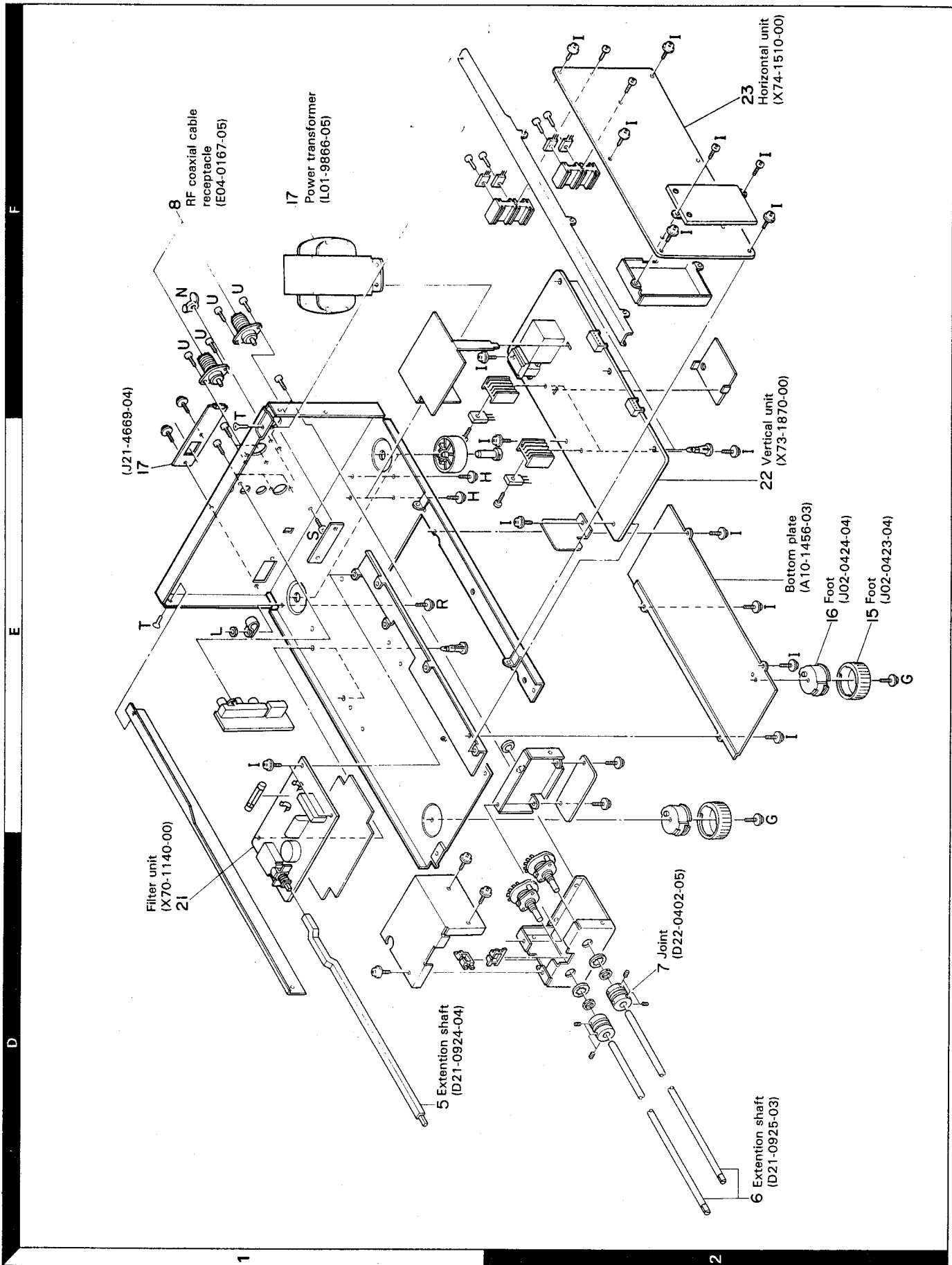

PACKING

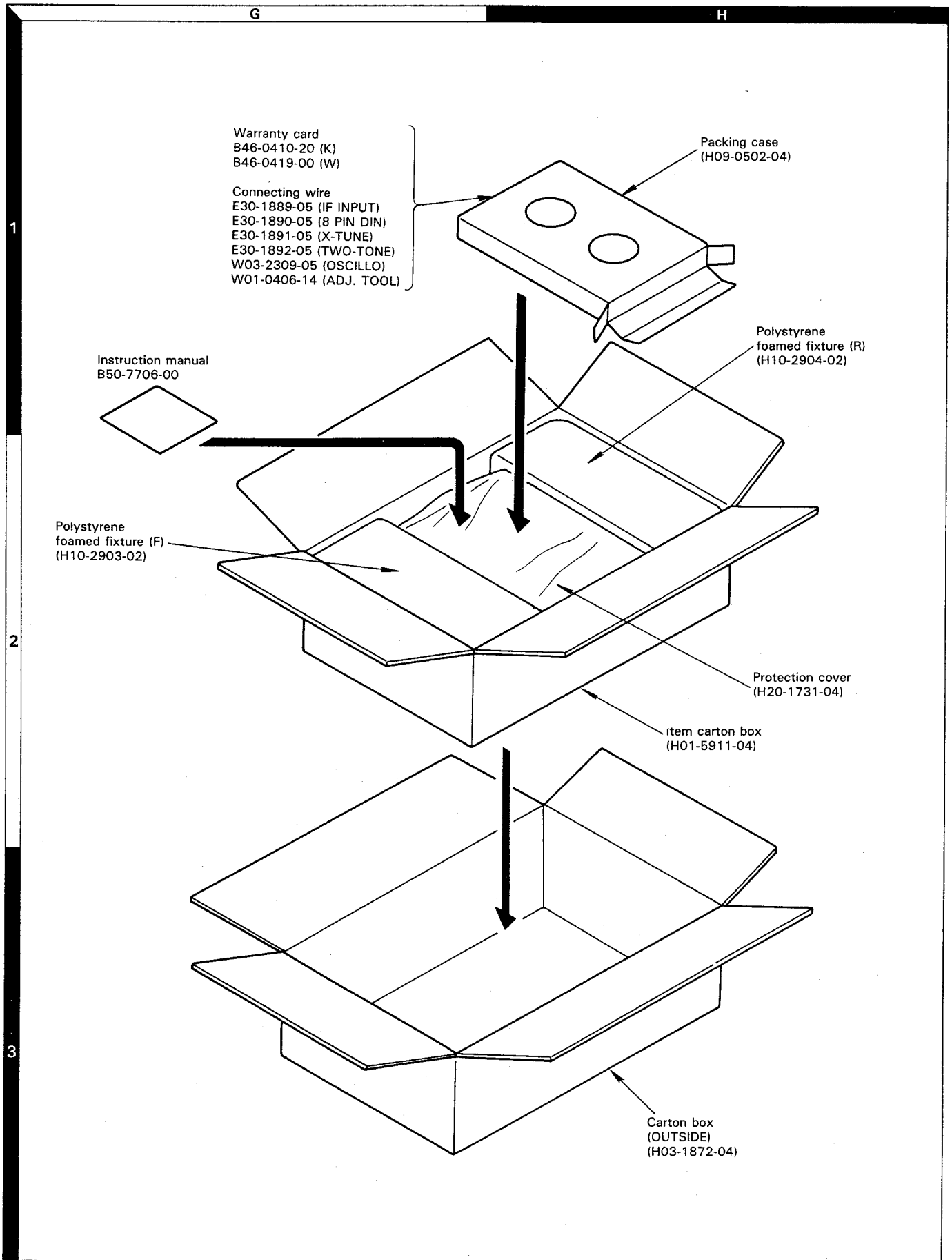



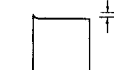
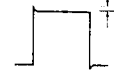
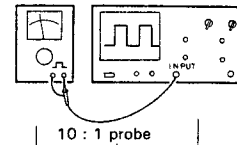
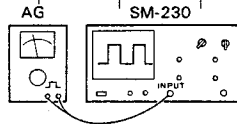

SM-230

ADJUSTMENT

Item	Condition	Measurement				Adjustment		Specification/Remarks			
		Test equipment	Unit	Terminal	Unit	Part	Method				
1. Supply voltage		DC volt-meter	Vertical power supply unit	P5-pin3	Vertical power supply unit	VR101	+ 10.00 V	± 0.01 V			
				P5-pin1			Check	$+ 140$ V ± 2.8 V			
				P5-pin4				$- 10$ V ± 0.2 V			
				P5-pin5				$+ 5$ V ± 0.1 V			
2. DC balance	FUNCTION: OSCILLOSCOPE ATTENUATION: 1 INPUT: None	Scope face				VR1	Adjust so that when the vertical VARIABLE knob setting is changed from MIN to MAX the position of the luminescent line does not vary.	Within ± 0.4 div.			
3. Waveform shaping	① FUNCTION: OSCILLOSCOPE ATTENUATION: 1 INPUT: 1 kHz square wave	Scope face	Vertical power supply unit					Within ± 0.05 div.			
	② INPUT: 100 Hz square wave								VR2		
	③ INPUT: 100 kHz square wave									Check	
4. 1/10 waveform shaping	FUNCTION: OSCILLOSCOPE ATTENUATION: 1/10 INPUT: 1 kHz square wave of 6 divisions					TC4		Within ± 0.05 div.			
5. 1/100 waveform shaping	FUNCTION: OSCILLOSCOPE ATTENUATION: 1/100, INPUT: 1 kHz square wave of 6 divisions					TC2					
6. 1/10 input capacity	FUNCTION: OSCILLOSCOPE ATTENUATION: 1/10, INPUT: 1 kHz square wave of 6 divisions 10 : 1 probe used					TC3					
7. 1/100 input capacity	FUNCTION: OSCILLOSCOPE ATTENUATION: 1/100, INPUT: 1kHz square wave	Scope face	Vertical power supply unit		Vertical power supply unit	TC1					



ADJUSTMENT

Item	Condition	Measurement			Adjustment			Specification/Remarks
		Test equipment	Unit	Terminal	Unit	Part	Method	
8. FOCUS	FUNCTION: X-TUNE FOCUS VR: Center	Scope face	Vertical power supply unit		Vertical power supply unit	VR151	Adjust the ASTIG VR on the front panel and VR 151 so that the spot is minimized.	Exact focusing should be obtained in 9 o'clock to 3 o'clock position of the FOCUS VR.
9. Luminescent line disappearance point	FUNCTION: OSCILLOSCOPE INTENSITY VR: 9 o'clock position					VR152	Adjust to a point at which the spot disappears.	
10. SWEEP TIME	FUNCTION: OSCILLOSCOPE SWEEP RANGE: 100 to 1 kHz, Horizontal VARIABLE VR: Clockwise MAX INPUT: 10 kHz, square wave	 VARIABLE 	Horizontal unit		Horizontal unit	VR1	Adjust so that a wave of 10 cycles appears on the scope face.	± 5%
11. Vertical sensitivity	FUNCTION: OSCILLOSCOPE ATTENUATION: 1 Vertical VARIABLE VR: Clockwise MAX INPUT: 1 kHz, 50 mV					 VARIABLE 	VR101	
12. TWO-TONE output	① Set the VR5 on the panel unit to its mechanical center. 1575 Hz tone switch: ON	AF VM				VR301	3.87 V	
	② 1000 Hz tone switch: ON					VR302		
	③ 1575 Hz and 1000 Hz tone switches: ON					VR303	5 mV	
13. Space position	FUNCTION: X-TUNE Input: None	Scope face				VR304	Adjust to the center of the scope face.	± 1 div
14. Mark position	FUNCTION: X-TUNE Input: None					VR306		

ADJUSTMENT

Item	Condition	Measurement			Adjustment		Specification/Remarks	
		Test equipment	Unit	Terminal	Unit	Part		Method
15. Band-scope sensitivity	FUNCTION: BAND SCOPE SSG output: 10 μ V Frequency: 8.830 MHz MODE: CW SCAN SPEED: SLOW	Scope face	Horizontal unit		Horizontal unit	T201	Adjust so that the amplitude is maximized on the scope face.	More than 1 div.
16. Band-scope band	FUNCTION: BAND SCOPE SSG output: 100 μ V Frequency: 8.830 MHz MODE: AM MOD. frequency: 20 kHz SCAN SPEED: SLOW SCAN WIDTH: \pm 25 kHz					VR201		\pm 10%
17. Band-scope band balance	FUNCTION: BANDSCOPE SSG output: 100 μ V Frequency: 8.830 MHz MODE: CW SCAN SPEED: SLOW					TC201 TC202	Adjust so that the \pm 250 kHz and \pm 25 kHz ranges are identical in respect to their centers.	\pm 5 kHz
18. Band-scope frequency position	FUNCTION: BAND SCOPE SSG output: 100 μ V Frequency: 8.830 MHz MODE: CW SCAN SPEED: SLOW					VR202	Set the scan start point to the left end on the scope face, and adjust the SSG output waveform to 6 divisions of the scale.	
19. Band scope submarker	FUNCTION: BAND SCOPE SSG output: 100 μ V Frequency: 8.830 MHz MODE: CW SCAN SPEED: SLOW Apply DC 2.5 V to the pin 7 of the DIN connector for the dual watch.					VR203	Adjust the luminance marker to the location of the 8.830 MHz waveform.	\pm 0.5 div.
20. SPACE sensitivity						VR305	Normally MAX	
21. MARK sensitivity						VR307		

ADJUSTMENT

Part installed face of vertical power supply unit (X73-1870-00)

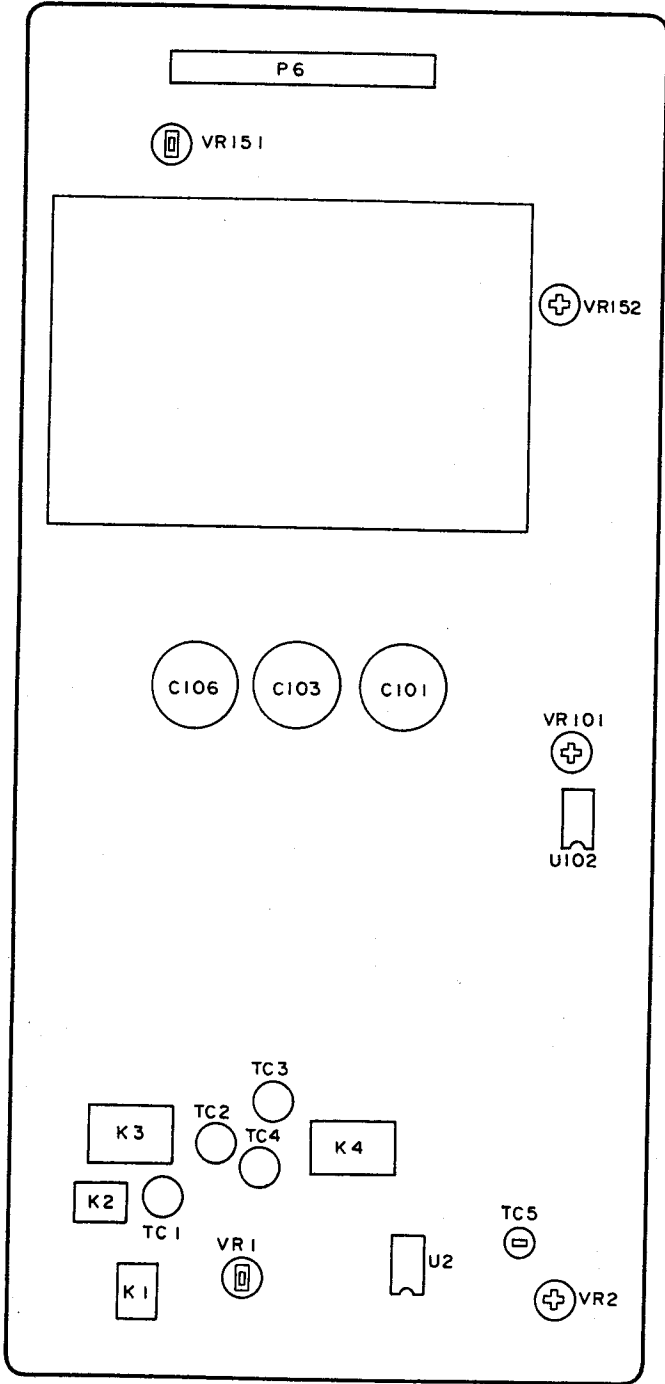

Part installed face of horizontal unit (X74-1510-00)

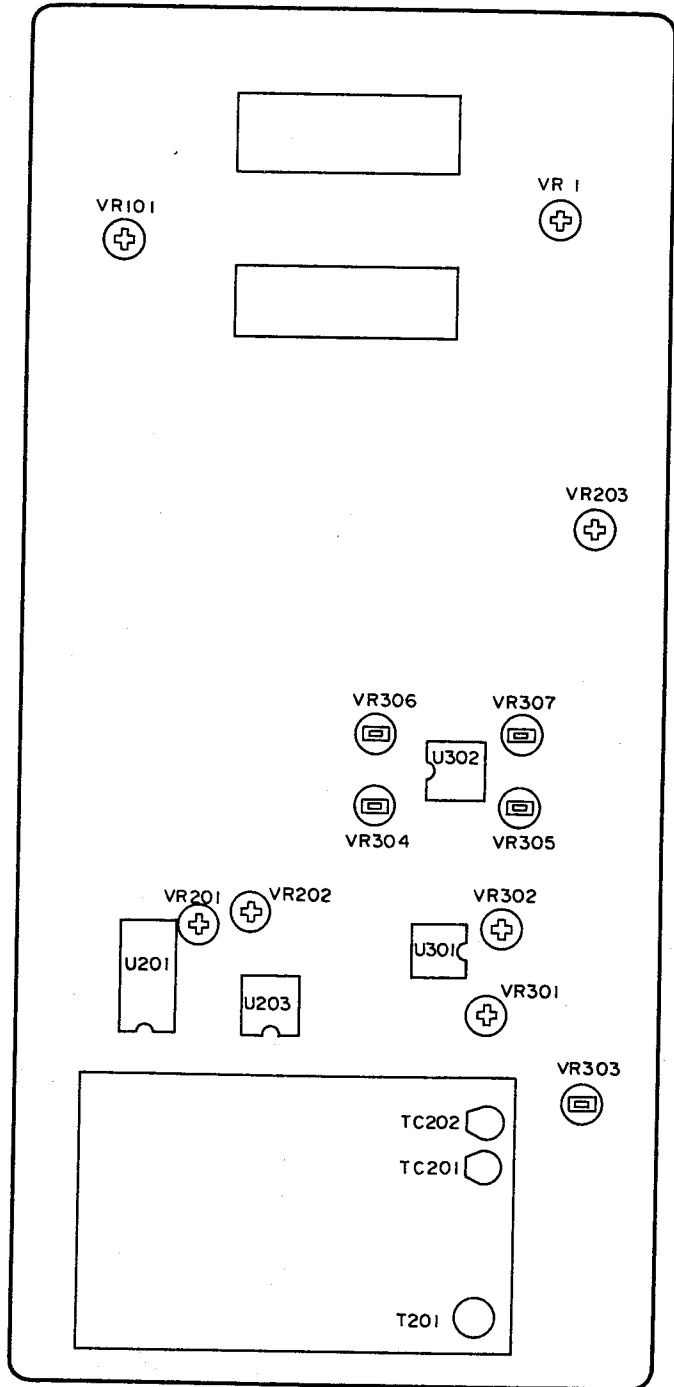

ADJUSTMENT

Bottom

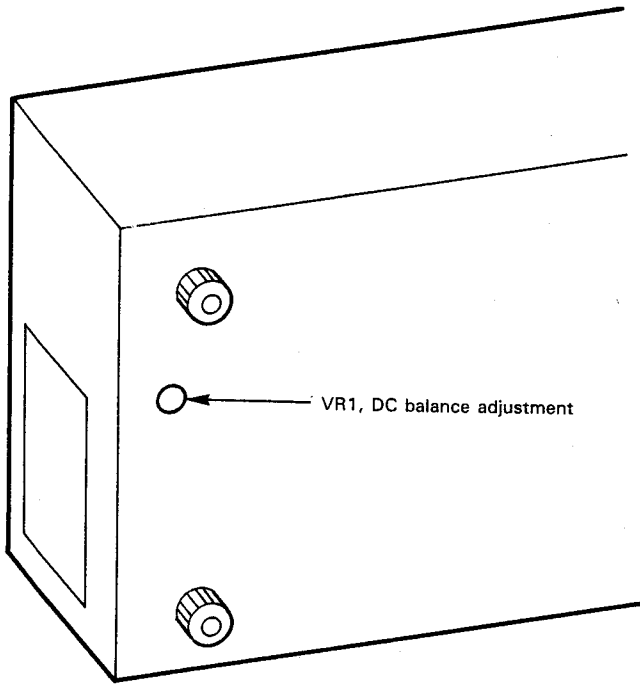

Right side

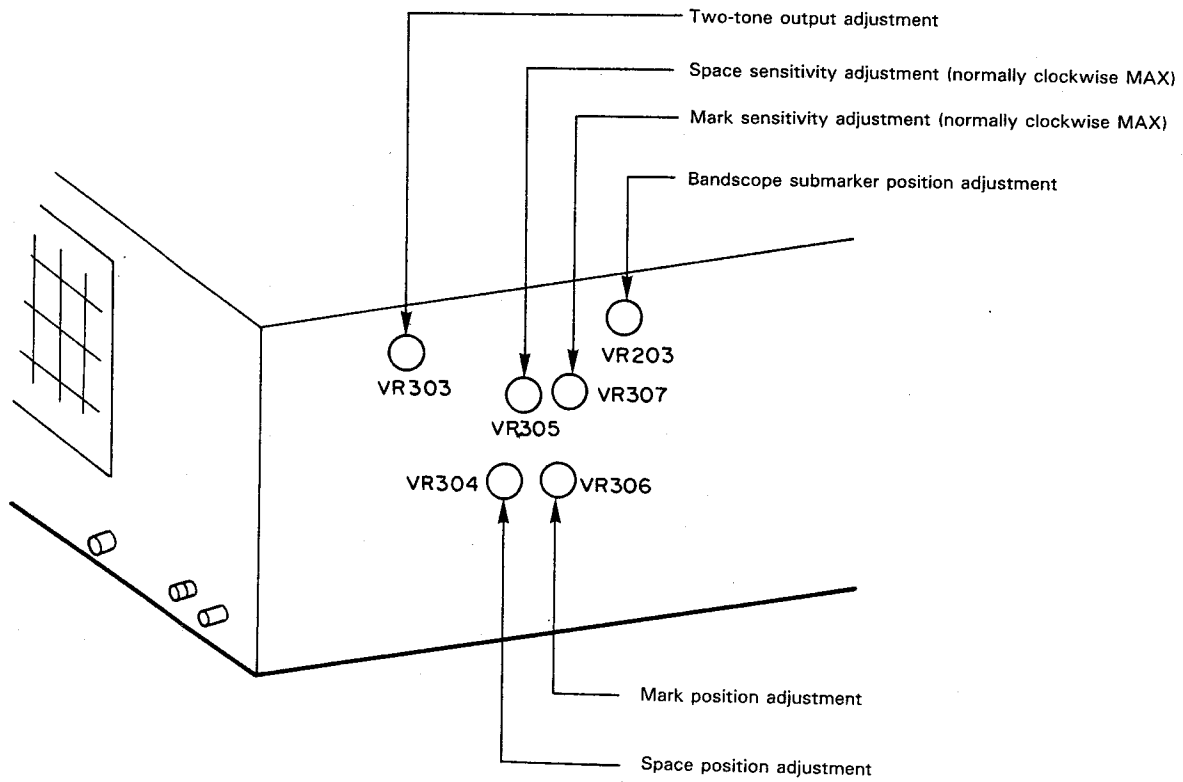

SM-230

PC BOARD VIEW

▼ PANEL UNIT (X69-1160-00)
[Component side view]

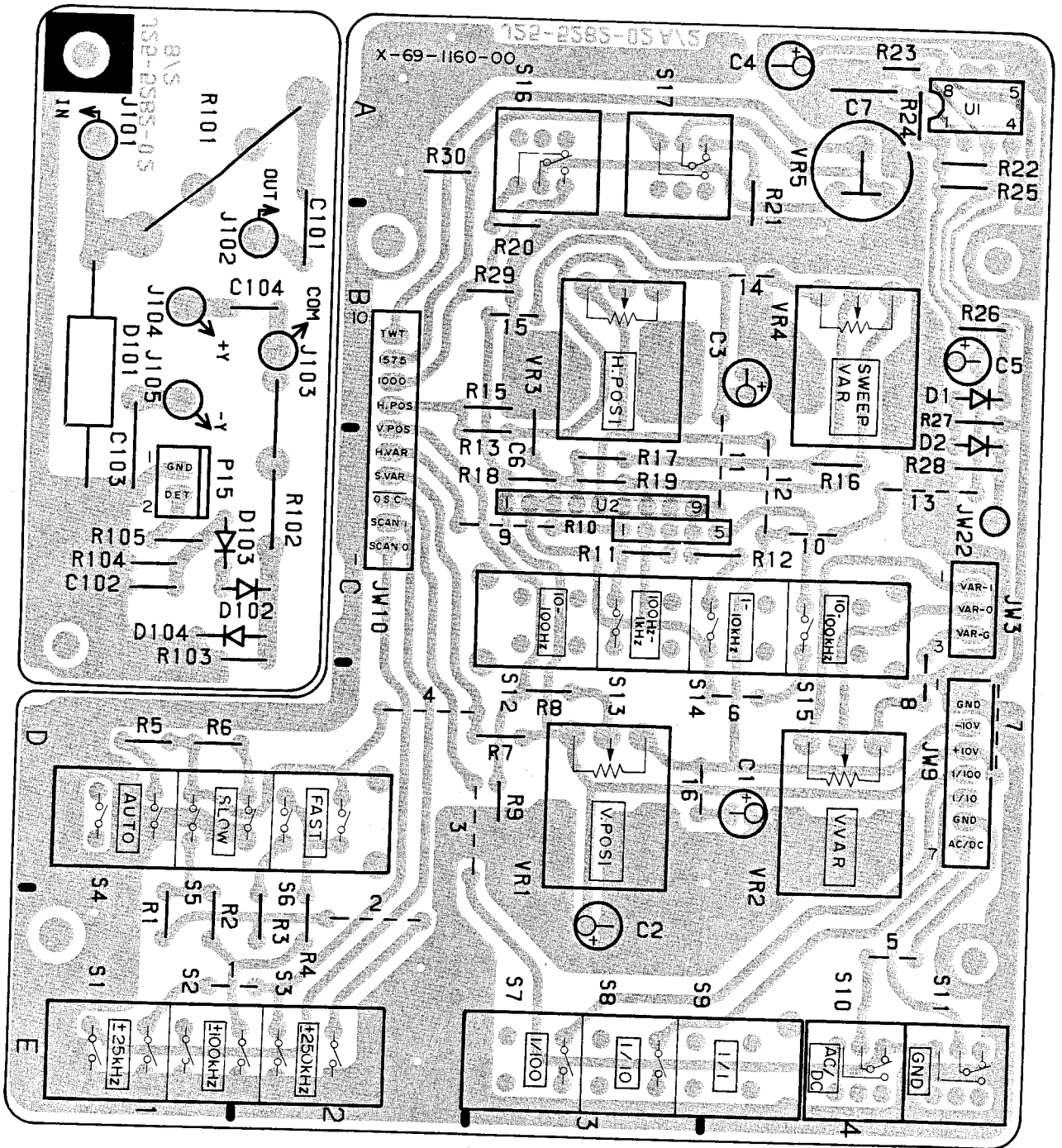

U1: NJM4558D U2: NJM072BS D1, 2: 1S132 D101: DSA-102MA D102, 103: MA700 D104: 1S1587

▼ PANEL UNIT (X69-1160-00)
[Foil side view]

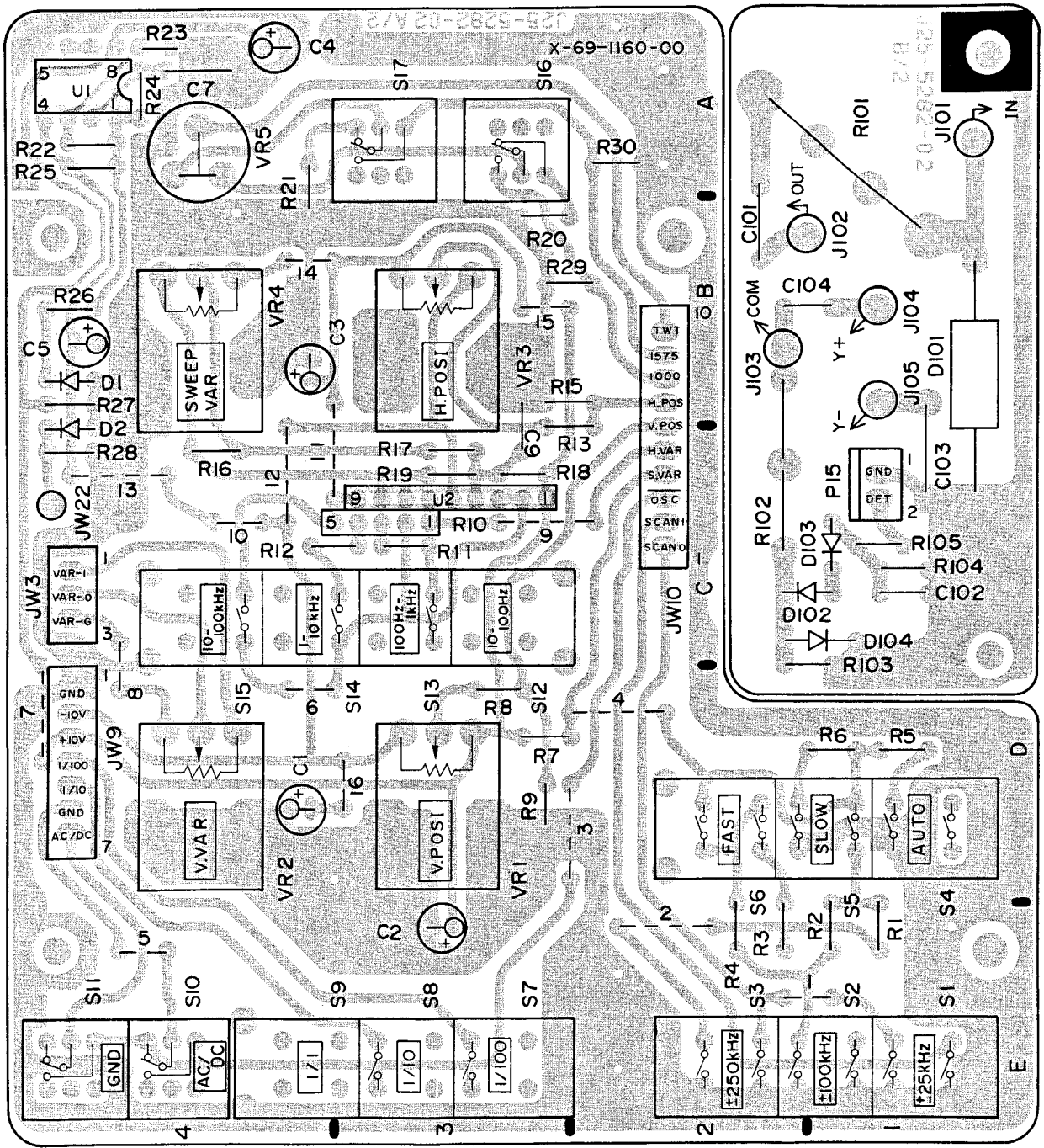

NJM4558D

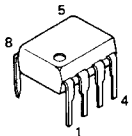

▼ FILTER UNIT (X70-1140-00)
[Component side view]

▼ FILTER
[Foil side view]

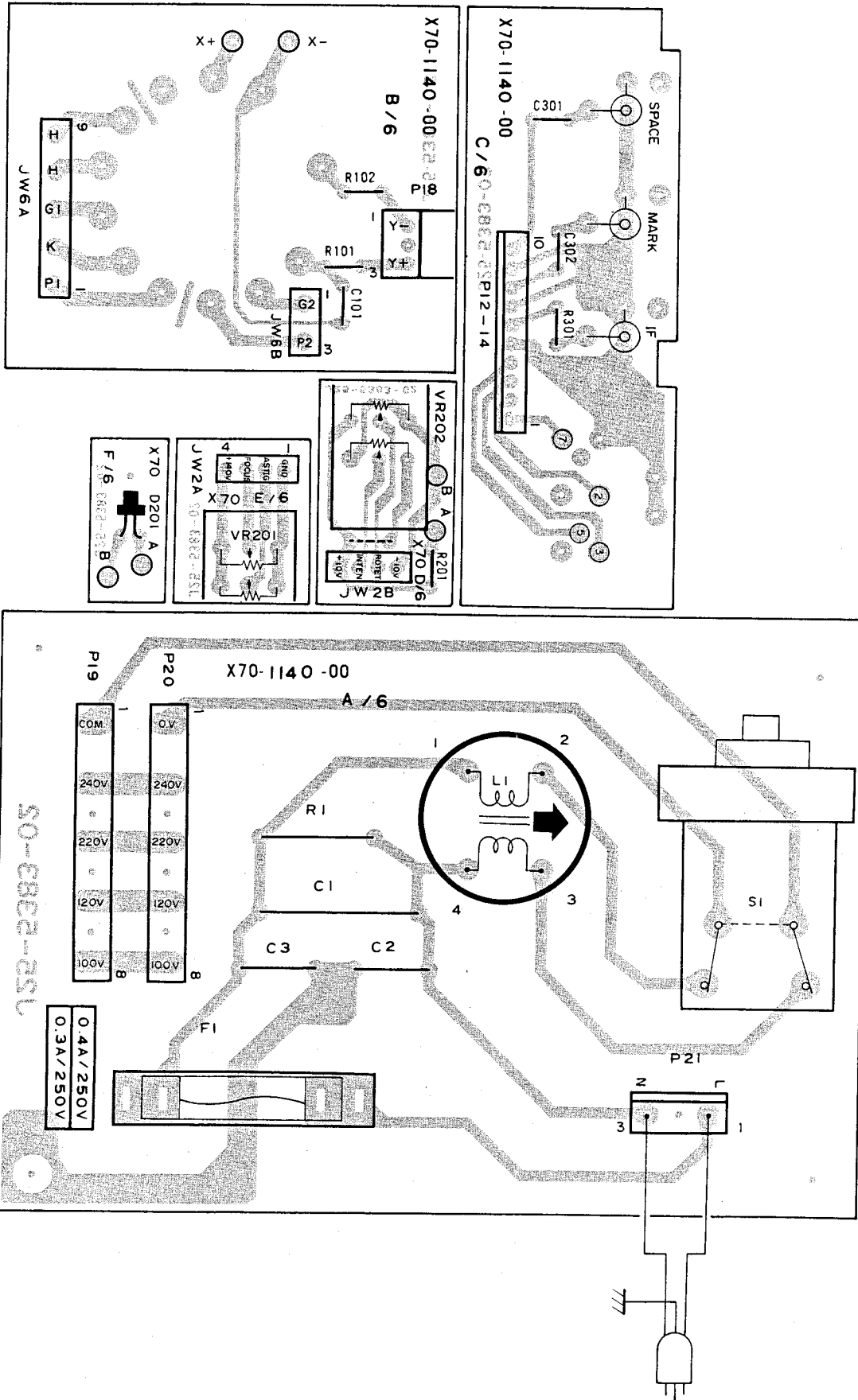

PC BOARD VIEW

▼ VERTICAL UNIT (X73-1870-00)
[Component side view]

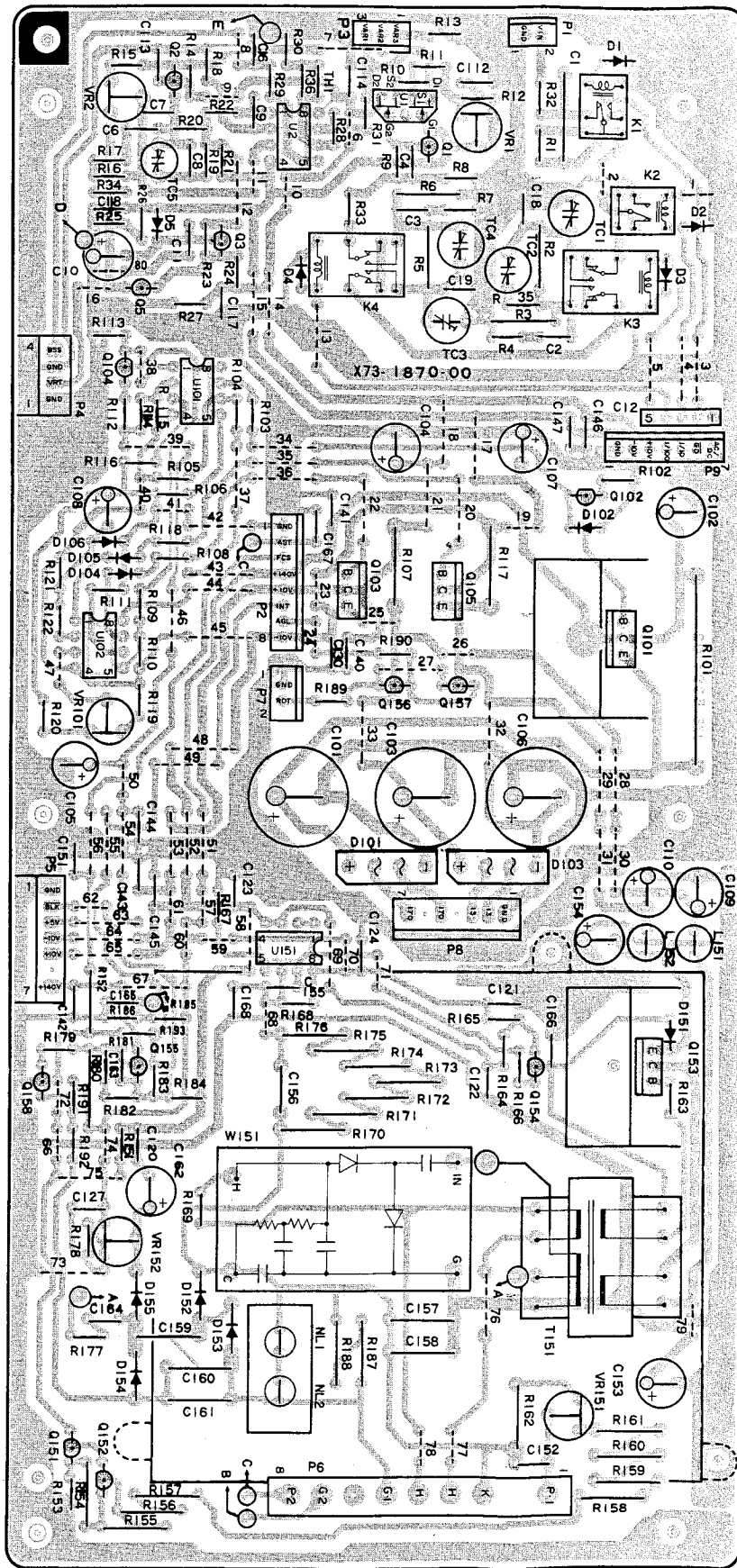

- U1: 2SK389 (GR) U2: NJM4558D U101, 102: NJM4558D U151: NJM4558D Q1: 2SC3315 Q2: 2SC2785 Q3: 2SC3779 Q5: 2SC3315
- Q101: 2SA1156 Q102: 2SC2271 Q103: 2SB1133 Q104: 2SC2785 Q105: 2SD1666 Q151, 152: 2SA1091 Q153: 2SD613
- Q154: 2SA1175 Q155: 2SC2909 Q156: 2SC1384 Q157: 2SA684 Q158: 2SA1207 D1~4: 1SS132 D5: MTZ5.1JB D101: S1VB60
- D102: 1SS132 D103: S1VB20 D104, 105: MTZ10JC D106: MTZ5.1JB D151: 1SS132 D152, 153: 1SR35-200 D154, 155: 1SS83

- ▼ VE [Foil s
- 2SA684
- 2SC138
- 2SD613
- 2SA117
- 2SC278
- 2SK389
- 2SA115
- NJM455
- TL082C

▼ VERTICAL UNIT (X73-1870-00)
[Foil side view]

2SA684
2SC1384

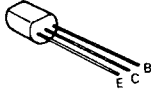

2SD613

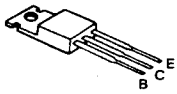

2SA1175
2SC2785

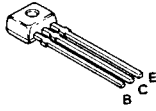

2SK389

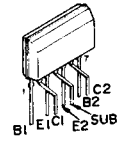

2SA1156

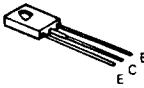

NJM4558D
TL082CP

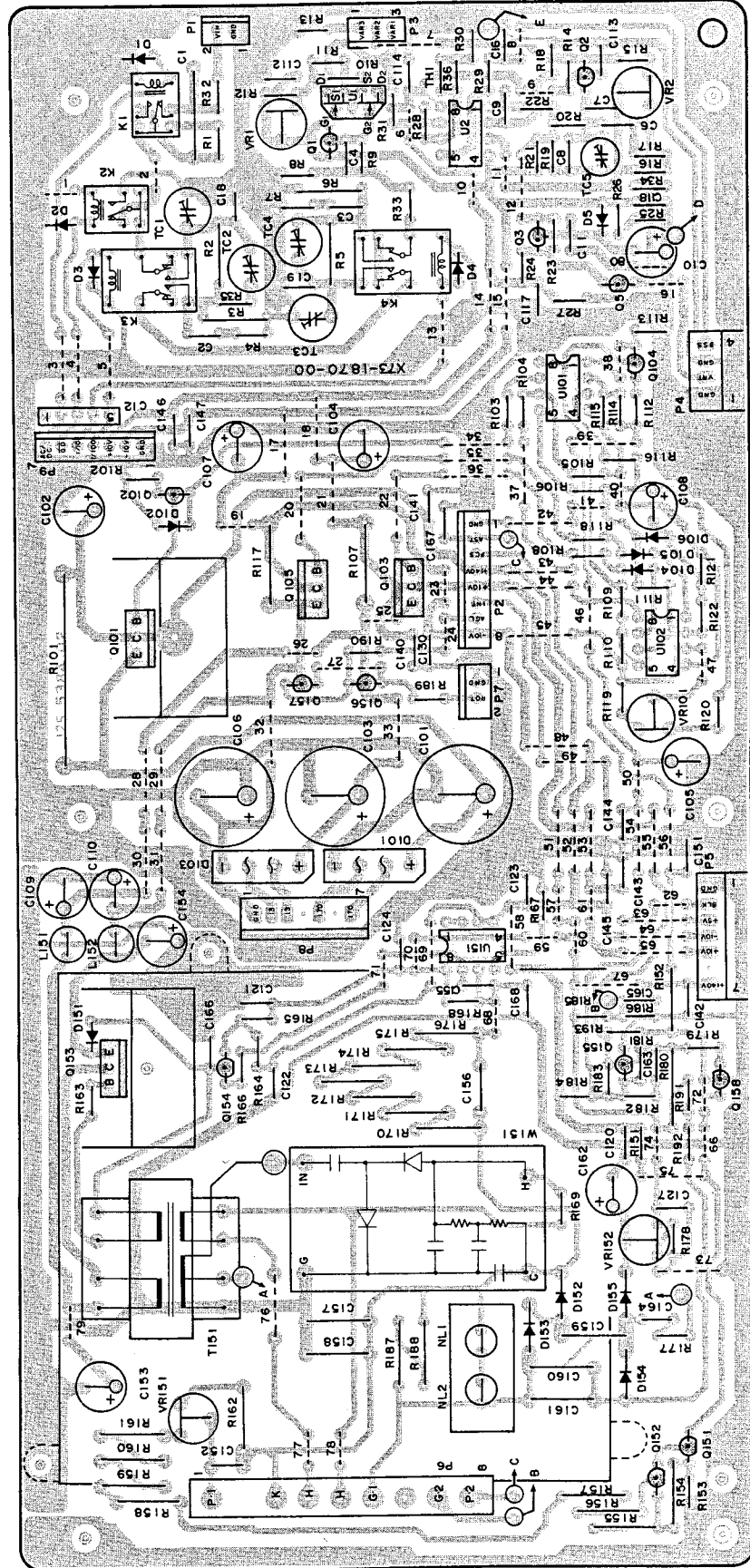
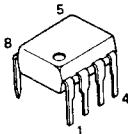

▼ HORIZONTAL UNIT (X74-1510-00)
 [Component side view]

U1: SN74LS00N U2: SN74LS112AN U3: 2SK332 U5: NJM072BS U6: TC4053BP U201: TC4053BP U202, 203: NJM4558D
 U301: NJM4558D U302: TL082CP O1~4: 2SC2785 O5: 2SA1175 O6: 2SC2785 O7: 2SA1206 O8: 2SA1175 O9: 2SC2785

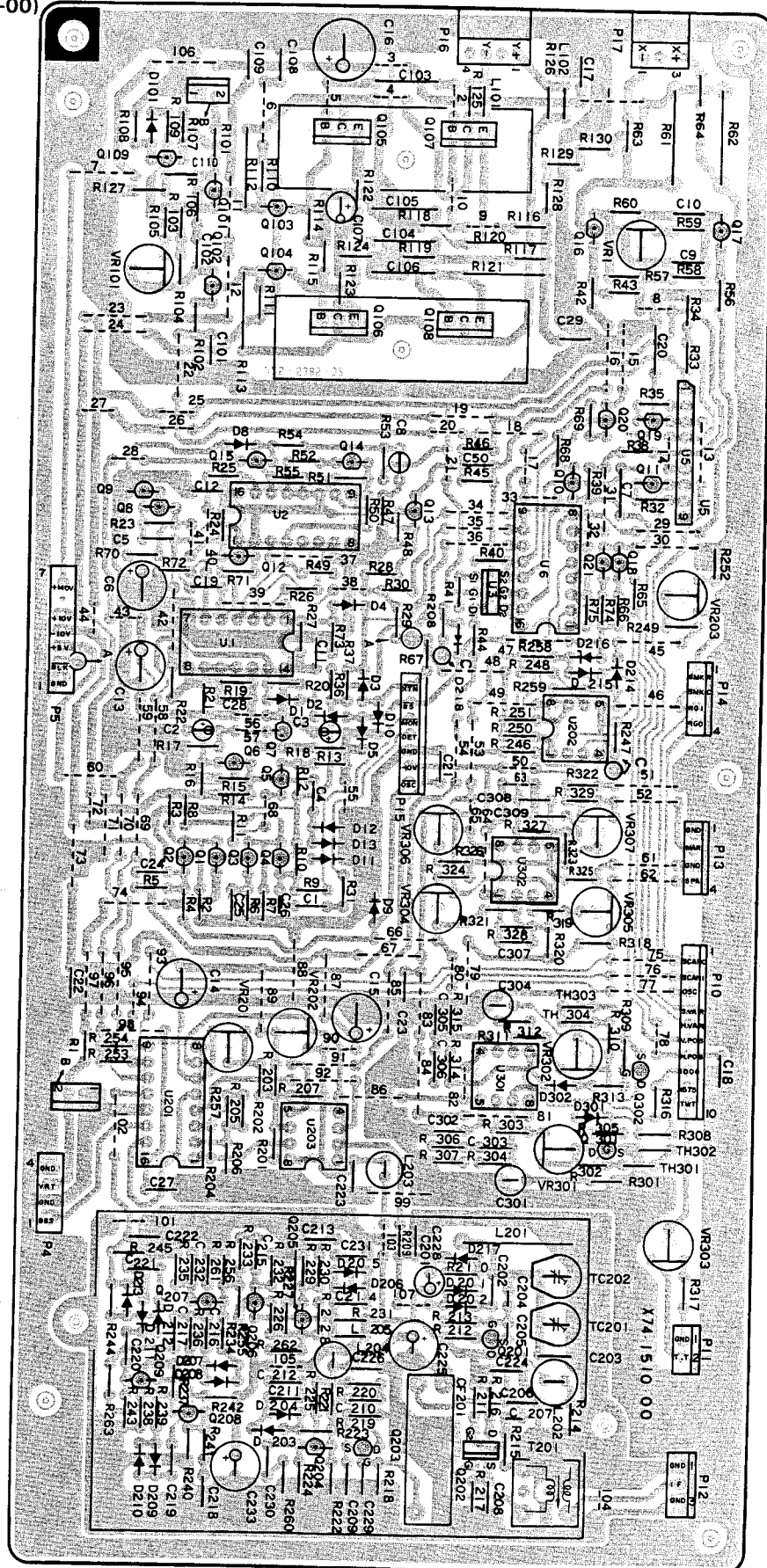

▼ HORIZONTAL UNIT (X74-1510-00)
 [Foil side view]

2SA1206
 2SA1175
 2SC2785
 SN74LS00N
 TC4053BP
 NJM072BS
 3SK73
 2SK192

▼ HORIZONTAL UNIT (X74-1510-00)
[Foil side view]

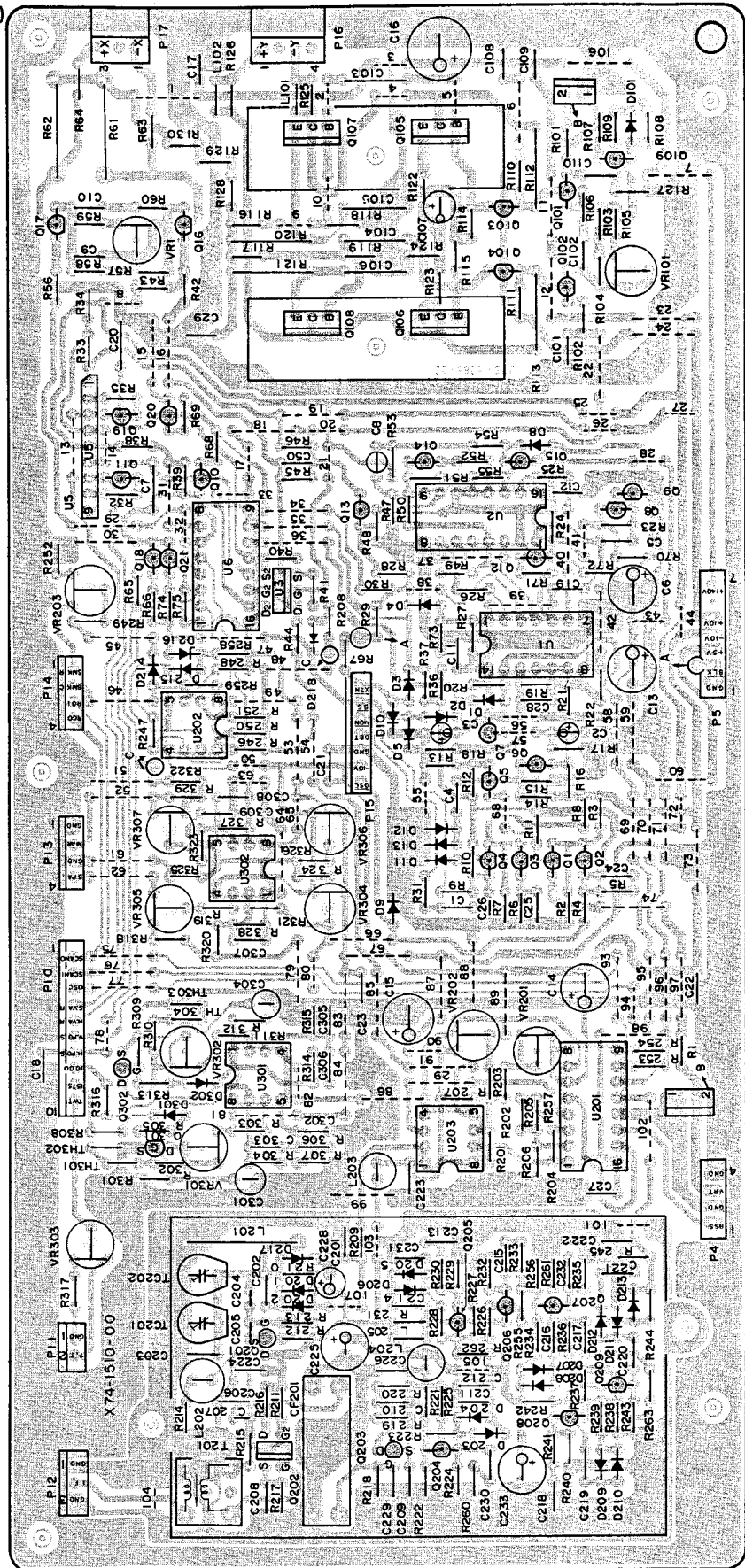
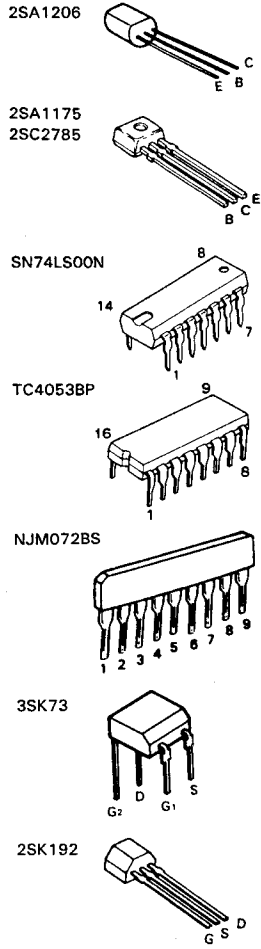

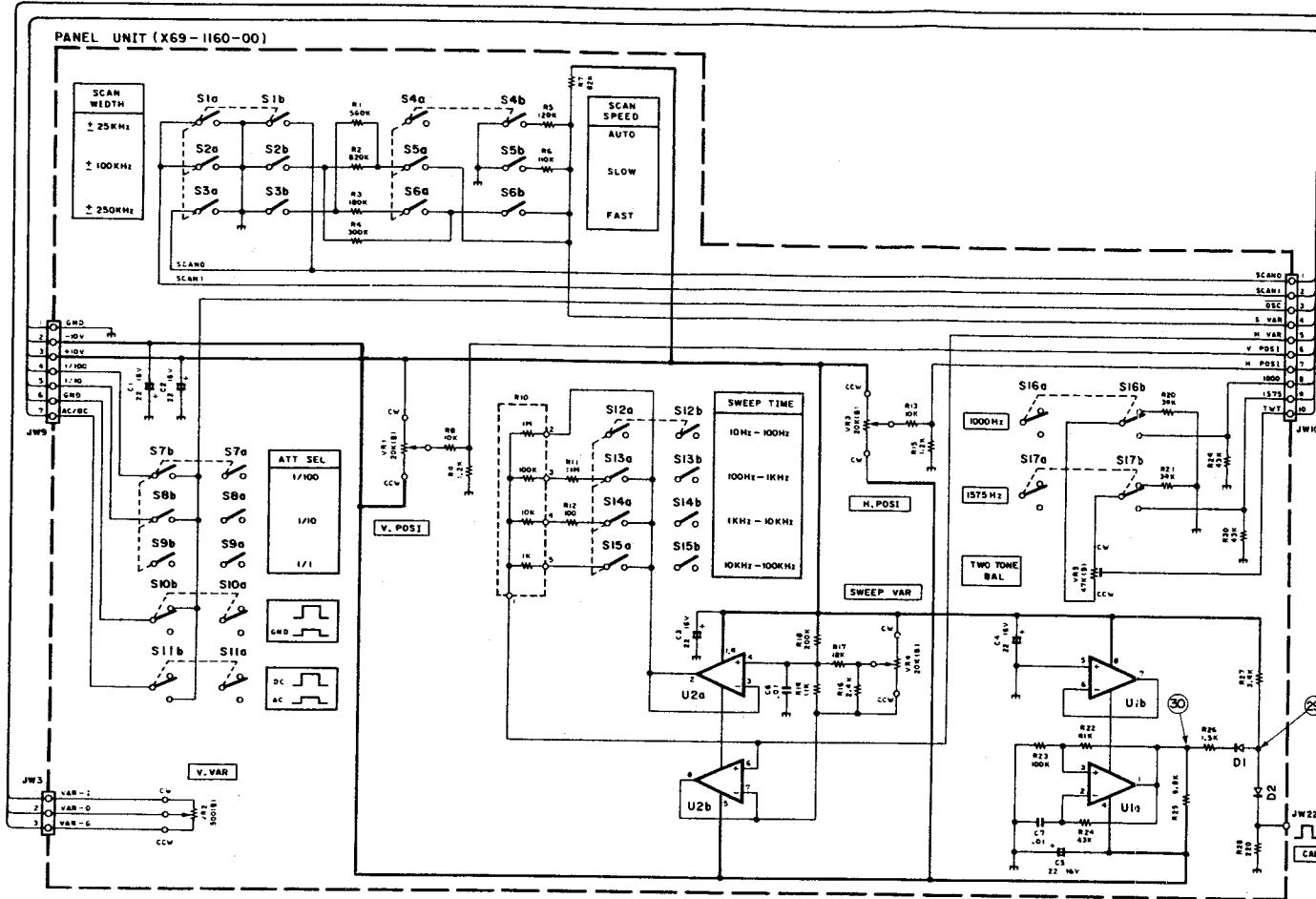

(X69-1160-00)

- U1 : NJM4558D
- U2 : NJM072BS
- D1, 2 : ISS132
- D101 : DSA-102MA
- D102, 103 : MA700
- D104 : IS1587

(X73-1870-00)

- U1 : 2SK389(GR)
- U2, 101, 102, 151 : NJM4558D
- Q1, 5 : 2SC3315(C, D)
- Q2, 104 : 2SC2785(F)
- Q3 : 2SC3779(D)
- Q101 : 2SB1156(L)
- Q102 : 2SC227(IID)
- Q103 : 2SB1133(S)
- Q105 : 2SD1666(S)
- Q151, 152 : 2SA109(IIO)
- Q153 : 2SD613(E)
- Q154 : 2SA1175(F)
- Q155 : 2SC2909(S, T)
- Q156 : 2SC1348(R)
- Q157 : 2SC1384(R)
- Q158 : 2SA1207
- D1~4, 102, 151 : ISS132
- D5, 106 : MTZ-5.1JB
- D101 : SIVB60
- D103 : SIVB20
- D104, 105 : MTZ-10JC
- D152, 153 : ISR35-200
- D154, 155 : ISSB3
- TH1 : I12-103-2

(X74-1510-00)

- U1 : SN74LS00N
- U2 : SN74LS112AN
- U3 : 2SK332(F)
- U5 : NJM072BS
- U6, 201 : TC4053BP
- U202, 203, 301 : NJM4558D
- U302 : TL082CP
- Q1~4, 6, 9, 12, 15, 204~209 : 2SC2785(F)
- Q5, 8, 11, 13, 14, 18, 19, 21 : 2SA1175(F)
- Q7 : 2SA1206
- Q10, 20 : 2SC3732(L)
- Q16, 17 : 2SC2909(S)
- Q101~104, 109 : 2SC3315(C)
- Q105, 106 : 2SC2911(S)
- Q107, 108 : 2SA1209(S)
- Q201 : 2SK192(GR)
- Q202 : 3SK73(GR)
- Q203, 301, 302 : 2SK404(F)
- D1, 4, 5, 8~11, 101, 203, 204, 207~210 : ISS132
- D2, 3 : MTZ10JC
- D12, 13, 205, 206, 211, 212 : MA700
- D201, 202 : ISV50
- D216 : MTZ5.1JB
- TH301~304 : I12-102-2

VERTICAL UNIT (X73-1870-00)

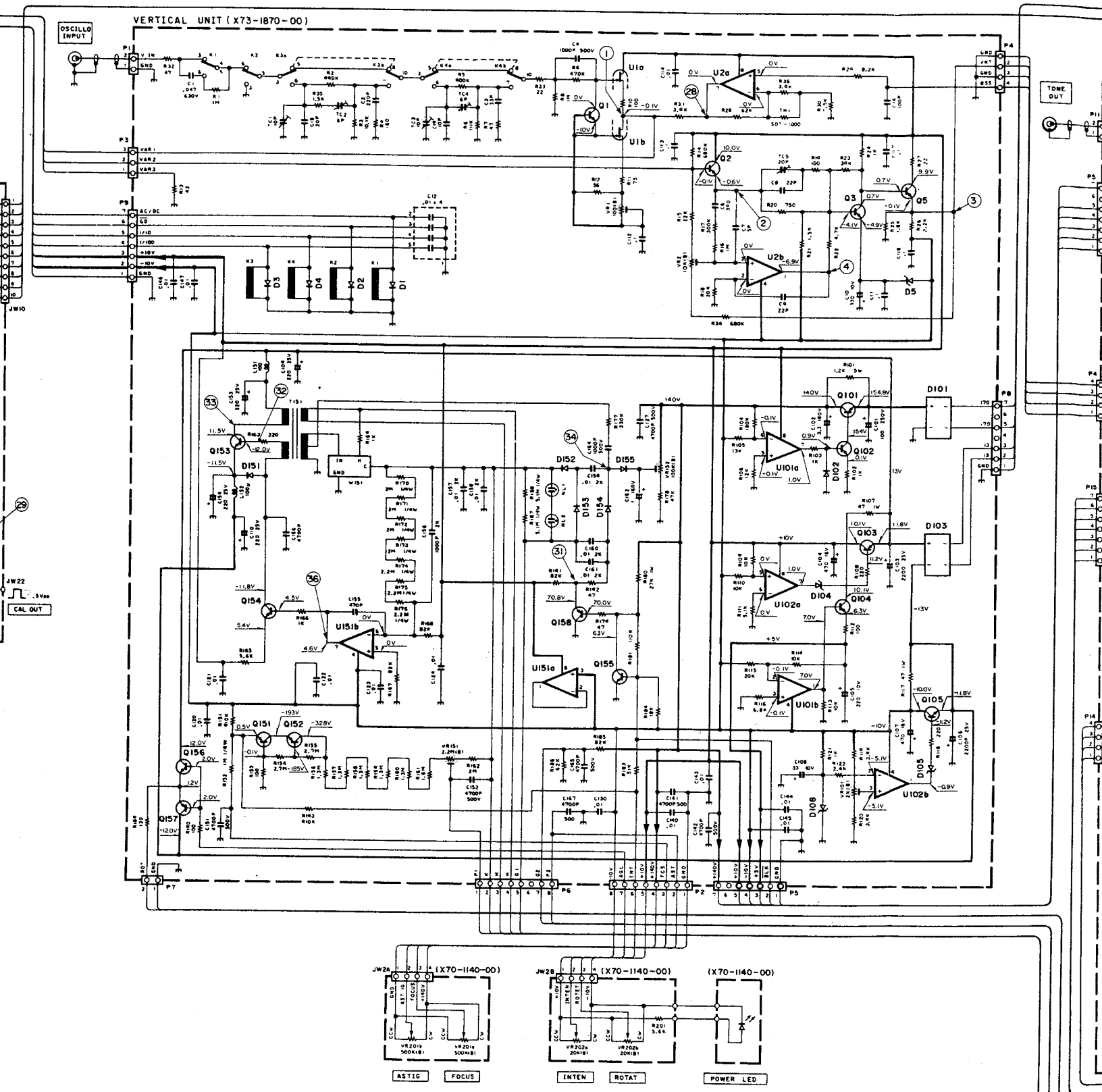

HORIZONTAL UNIT (X74-1510-00)

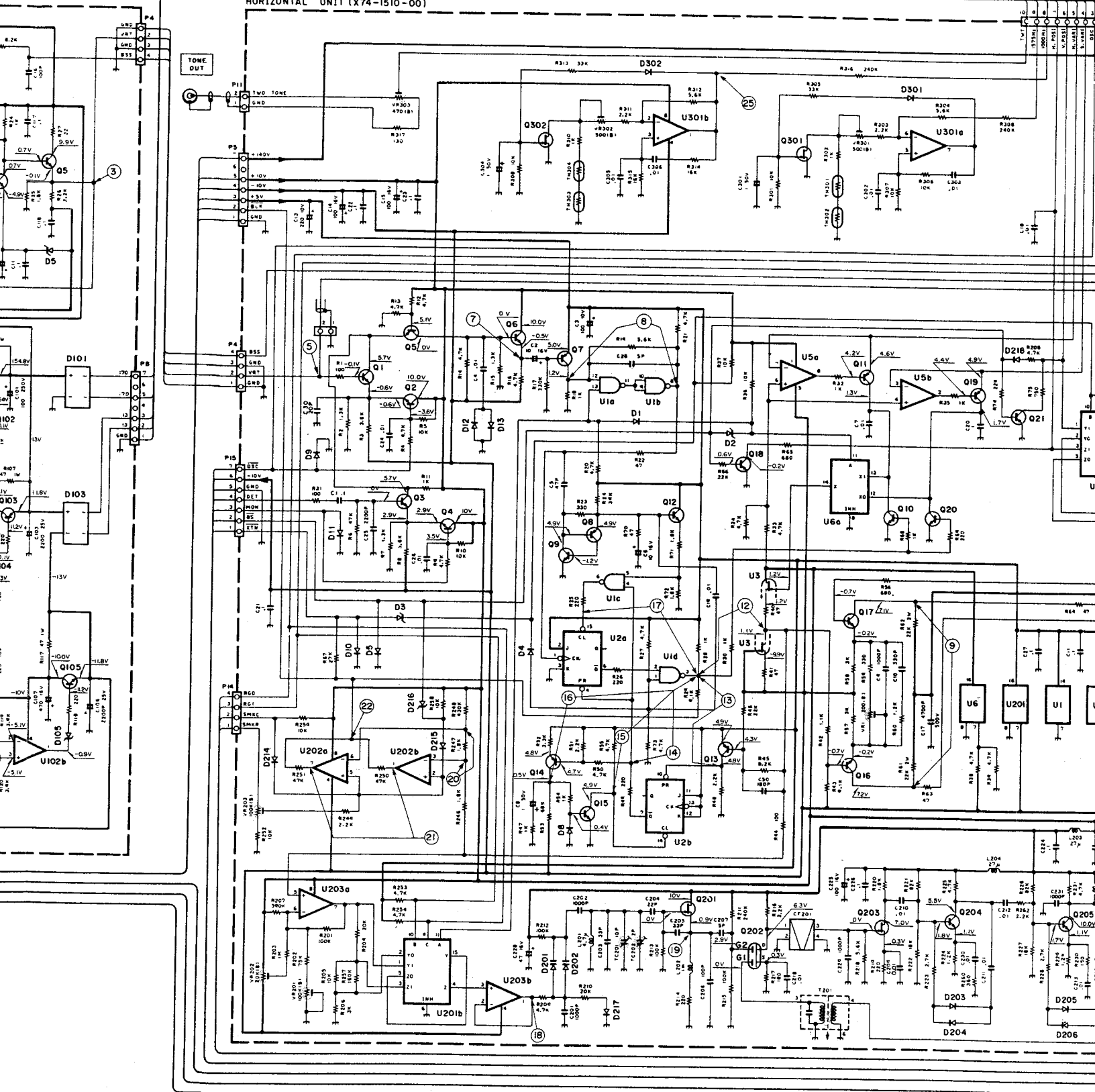

HORIZONTAL UNIT (X74-1510-00)

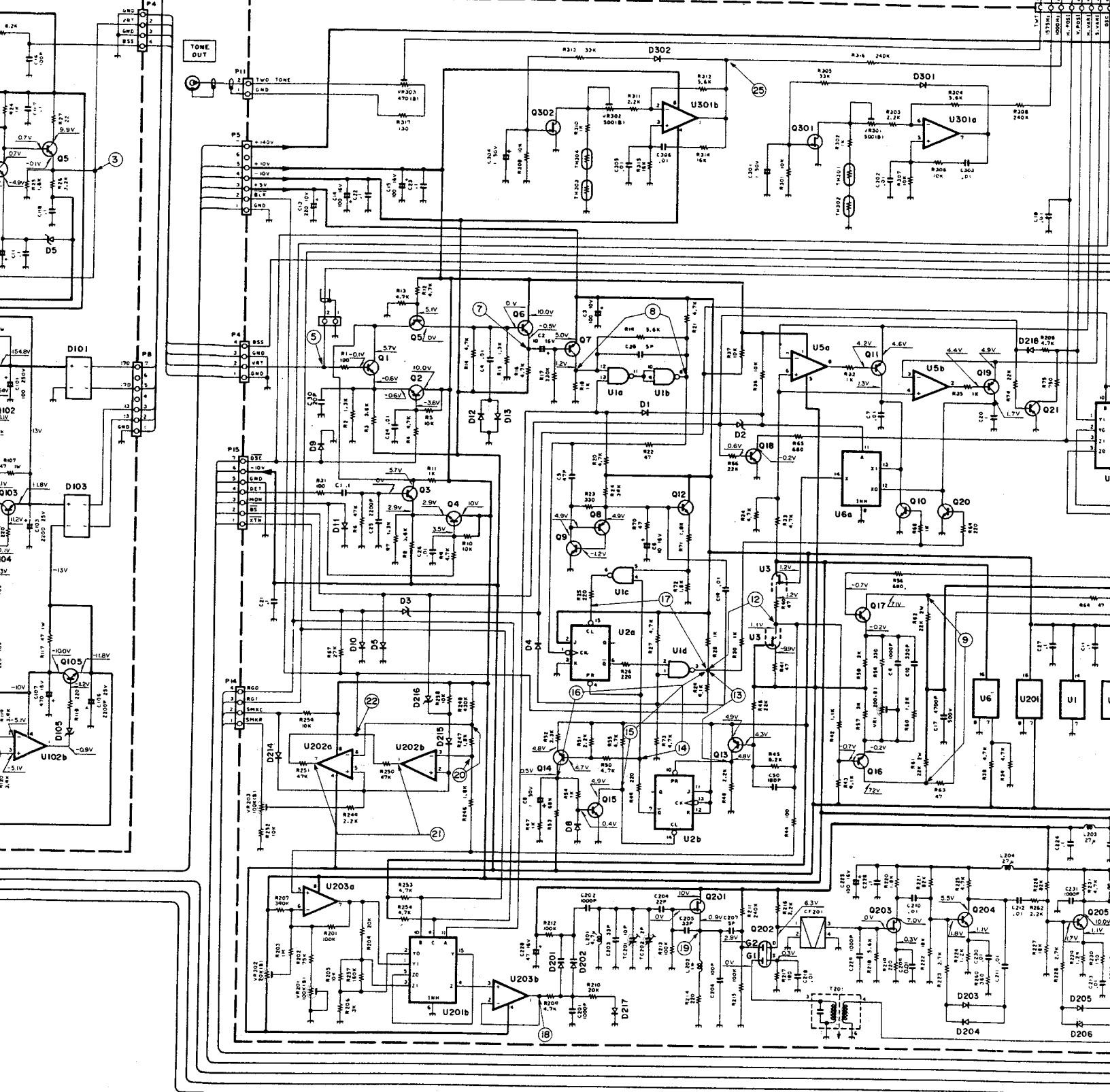

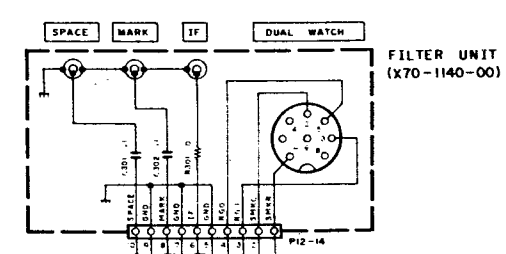
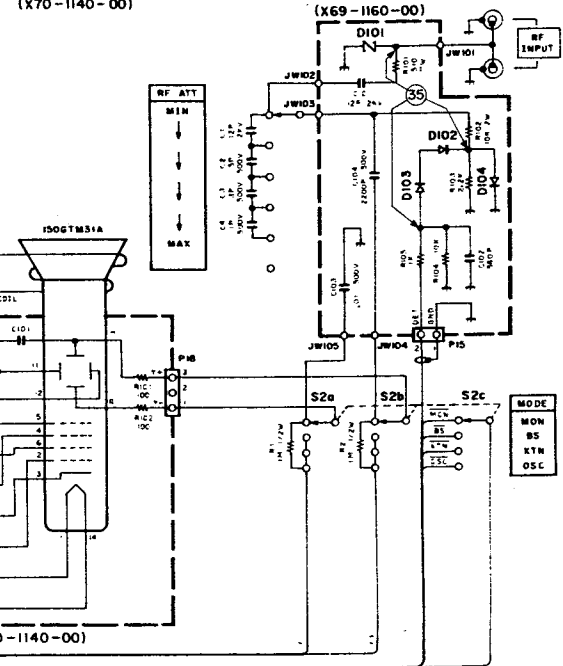
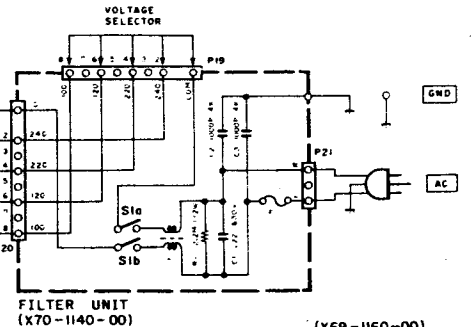
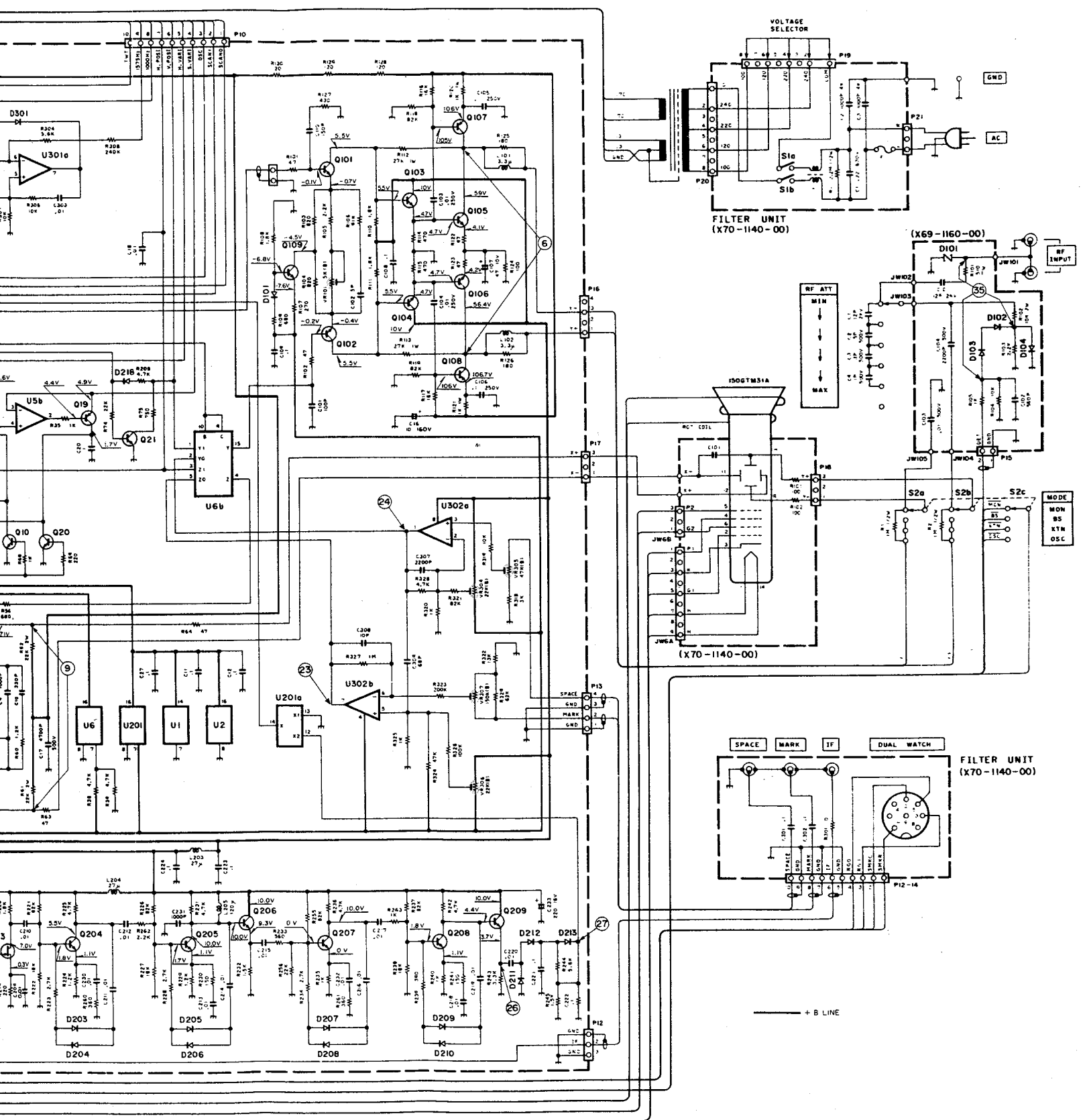

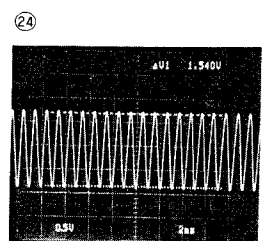
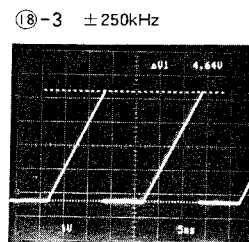
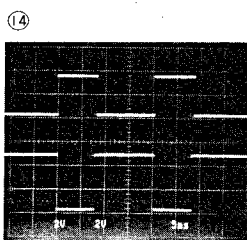
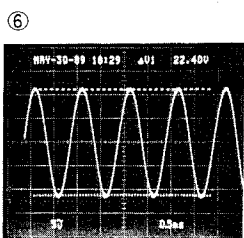
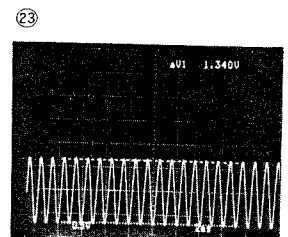
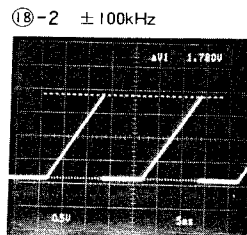
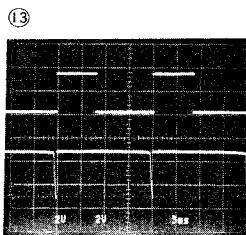
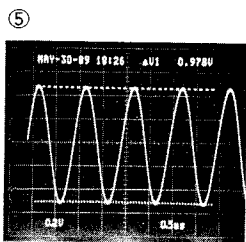
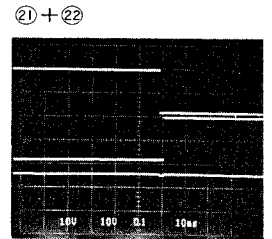
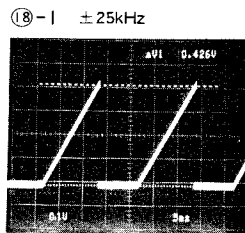
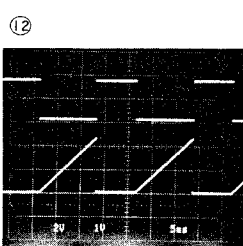
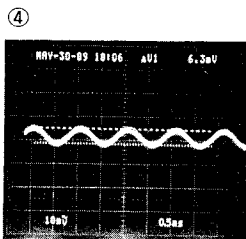
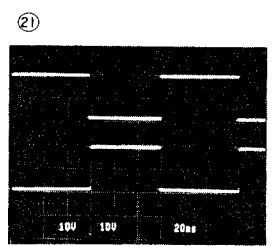
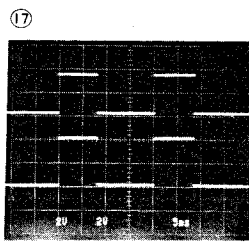
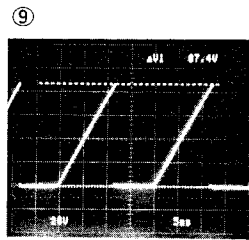
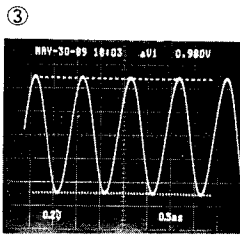
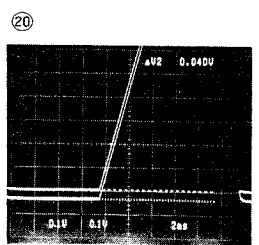
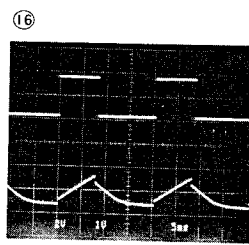
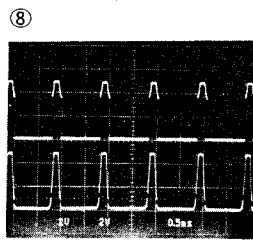
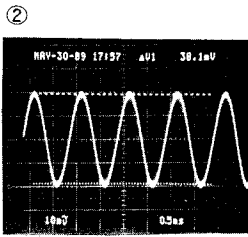
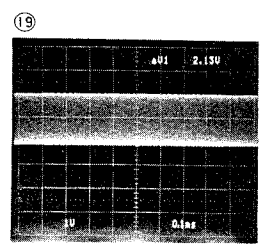
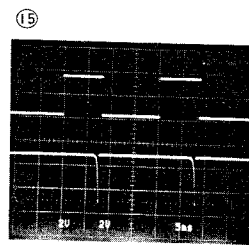
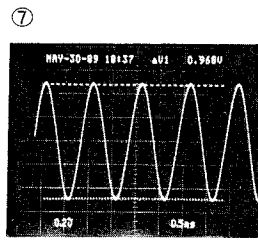
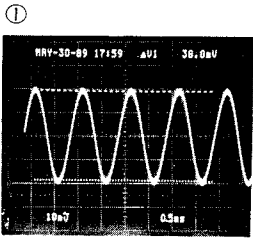

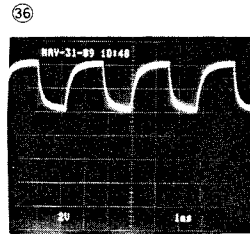
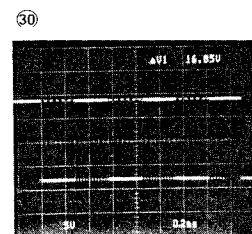
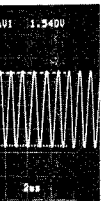
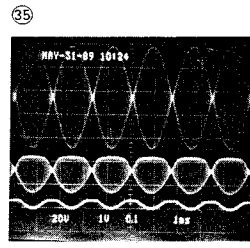
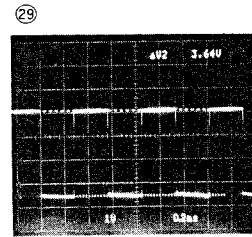
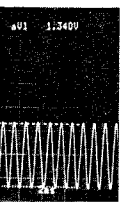
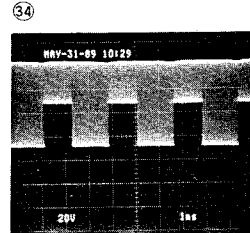
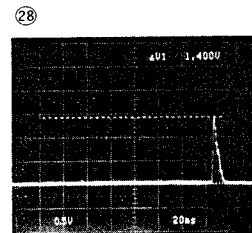
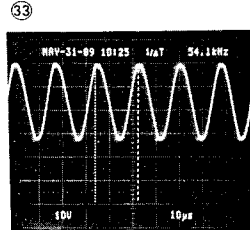
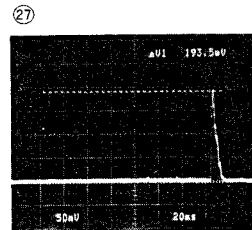
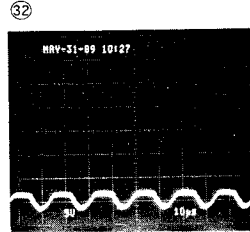
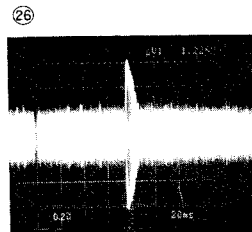
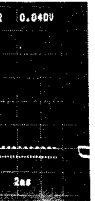
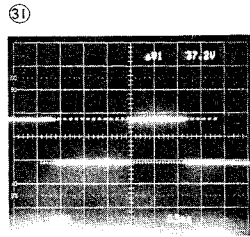
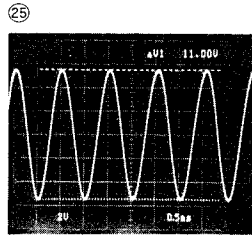
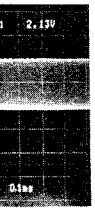

«Conditions»

OSC MODE

Input : 50 mVp-p, 1 kHz

ATT : 1/1

V-Vari : NORM

Horizontal : Any position

X-TUNE MODE

Input : 300 mVp-p 1 kHz

Band-Scope MODE

Input : 1 mVrms 8.83 MHz

Monitor MODE

Input : Approx. 10 W 7 MHz Two Tone

BLOCK DIAGRAM

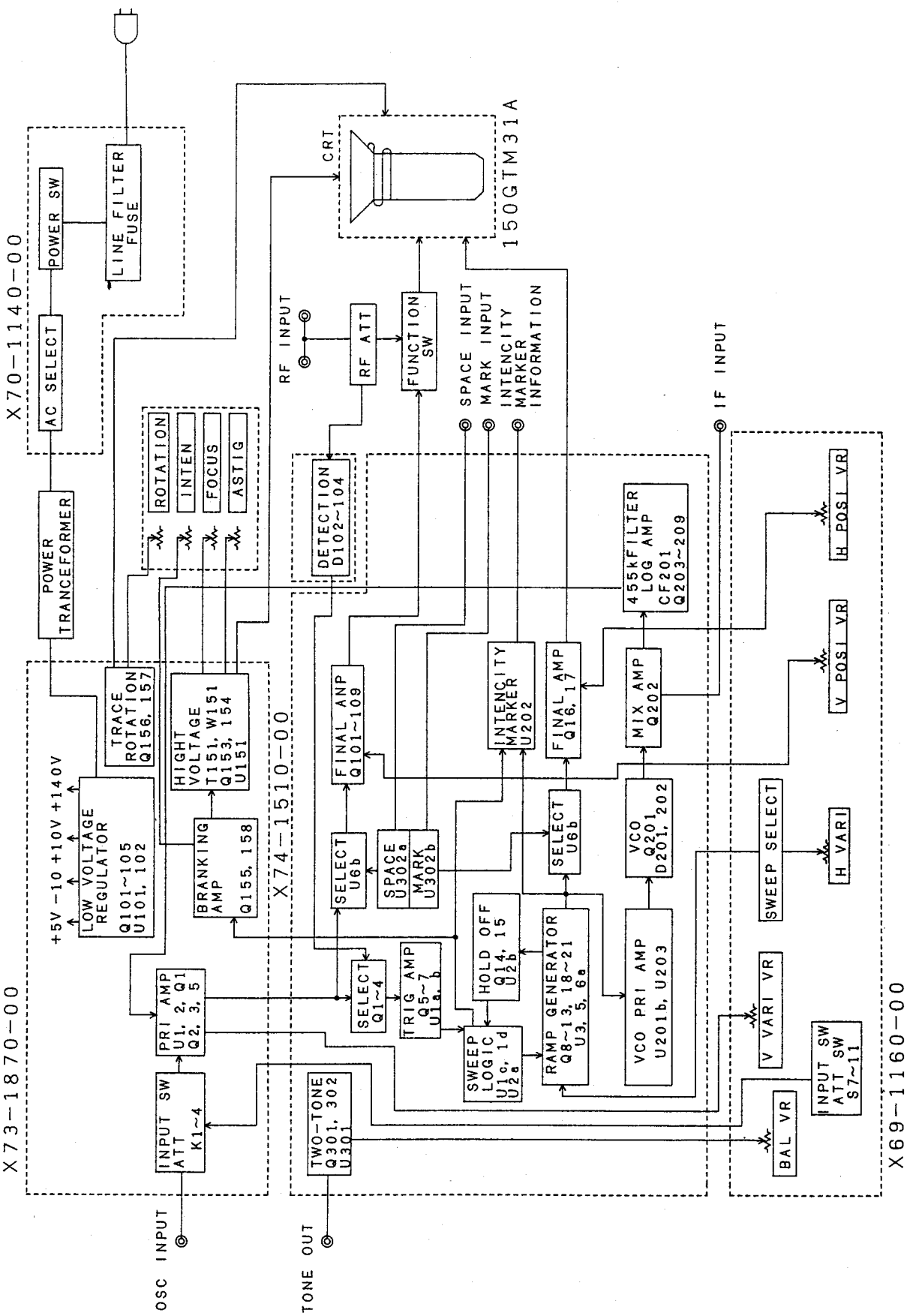

C. R. T
 TRANS
 Frequen
 Maxim
 PAN DI
 Input c
 Input s
 Scan w
 TWO-T
 Oscillat
 Output
 Output
 VERTIC
 Deflect
 Input in
 Frequen
 Max. in
 SWEEP
 Sweep
 Sync. s
 POWER
 OPERA
 DIMENS
 Project
 Project
 Weight

SM-230

SPECIFICATIONS

C. R. T.	150GTM31A 6 inch square
TRANSMIT SIGNAL MONITOR TERMINAL	
Frequency range	1.8 ~ 150 MHz
Maximum power	1.8 ~ 30 MHz 2 KW PEP MAX. 5MIN. at ATT MAX 30 ~ 150 MHz 100 W PEP
PAN DISPLAY	
Input center frequency	8.830 MHz
Input sensitivity	More than 20 dB μ /DIV
Scan width	\pm 25 KHz, \pm 100 KHz, \pm 250 KHz selectable
TWO-TONE GENERATOR	
Oscillator frequency	1000 Hz, 1575 Hz \pm 10%
Output voltage	5 mVrms \pm 20%
Output impedance	600 Ω
VERTICAL AMPLIFIER	
Deflection sensitivity	10 mV ~ 10 V/DIV (In 3 ranges, variable)
Input impedance/capacity	1M Ω Less than 50 pF
Frequency response	DC ~ 10 MHz (-3 dB)
Max. input voltage	500 Vp-p or 250 V (DC-AC peak)
SWEEP CIRCUIT	
Sweep frequency	10 Hz ~ 100 KHz (In 4 ranges, variable)
Sync. system	Synchronized sweep
POWER SUPPLY	
	120 V (K) \pm 10%
	220 V (W) \pm 10%
	120-220-240 V (-10% ~ 250 V) (M)
OPERATING TEMPERATURE	0 $^{\circ}$ C ~ 50 $^{\circ}$ C
DIMENSIONS (W \times H \times D)	
Projections not included (mm)	260 \times 141 \times 400
Projections included (mm)	260 \times 155 \times 427
Weight	7.5 Kg

KENWOOD CORPORATION

Shionogi Shibuya Building, 17-5, 2-chome Shibuya, Shibuya-ku, Tokyo 150, Japan

KENWOOD U.S.A. CORPORATION

COMMUNICATIONS & TEST EQUIPMENT GROUP

P.O. BOX 22745, 2201 East Dominguez St., Long Beach, CA 90801-5745, U.S.A.

KENWOOD ELECTRONICS DEUTSCHLAND GMBH

Rembrücker Str. 15, 6056 Heusenstamm, West Germany

KENWOOD ELECTRONICS BENELUX N.V.

Mechelsesteenweg 418 B-1930 Zaventem, Belgium

TRIO-KENWOOD FRANCE S.A.

13, Boulevard Ney, 75018 Paris, France

KENWOOD LINEAR S.P.A.

20125, Milano-via Arbe, 50, Italy

KENWOOD ELECTRONICS AUSTRALIA PTY. LTD.

(INCORPORATED IN N.S.W.)

4E, Woodcock Place, Lane Cove, N.S.W. 2066, Australia

KENWOOD & LEE ELECTRONICS, LTD.

Wang Kee Building, 5th Floor, 34-37, Connaught Road, Central, Hong Kong

KENWOOD ELECTRONICS CANADA INC.

P.O. BOX 1075, 959 Gana Court, Mississauga, Ontario, Canada L4T 4C2

KENWOOD

SB-970

SERVICE BULLETIN AMATEUR RADIO

SUBJECT SM-230 BANDSCOPE ATTENUATION	DATE 05/29/90
---	------------------

When the SM-230 is used as a bandscope, the attenuator circuit is bypassed. Sometimes it is necessary to use the attenuator during strong signal reception or high noise conditions. The following modification will allow the attenuator circuit to function in the bandscope mode.

REQUIRED PARTS:

W05-0309-00 ATT SUB-UNIT

1. Disconnect the power cord and patch cords.
2. Remove the top cover (6 screws).
3. Remove the Horizontal unit's mounting screw and secure the ATT sub-unit with the supplied 2.6mm screw and washer.
4. Remove connector P12 from the Horizontal unit and insert it into jack P1 on the ATT sub-unit.
5. Insert connector JA from the ATT sub-unit into jack P12 on the Horizontal unit.
6. Insert the two wire plug, supplied in the kit, into jack P2 on the ATT sub-unit.
7. Solder the exposed ends of the red and the brown wires to the Panel unit as shown in figure 2.
8. Solder the two jumper wires (they look like resistors) as shown in figure 2.

PAGE 1 OF 2

This modification may be covered under warranty.
Time required to perform the modification is 0.5 hrs. or less.
Copyright (C) 060190EWP for Kenwood U.S.A. Corporation.

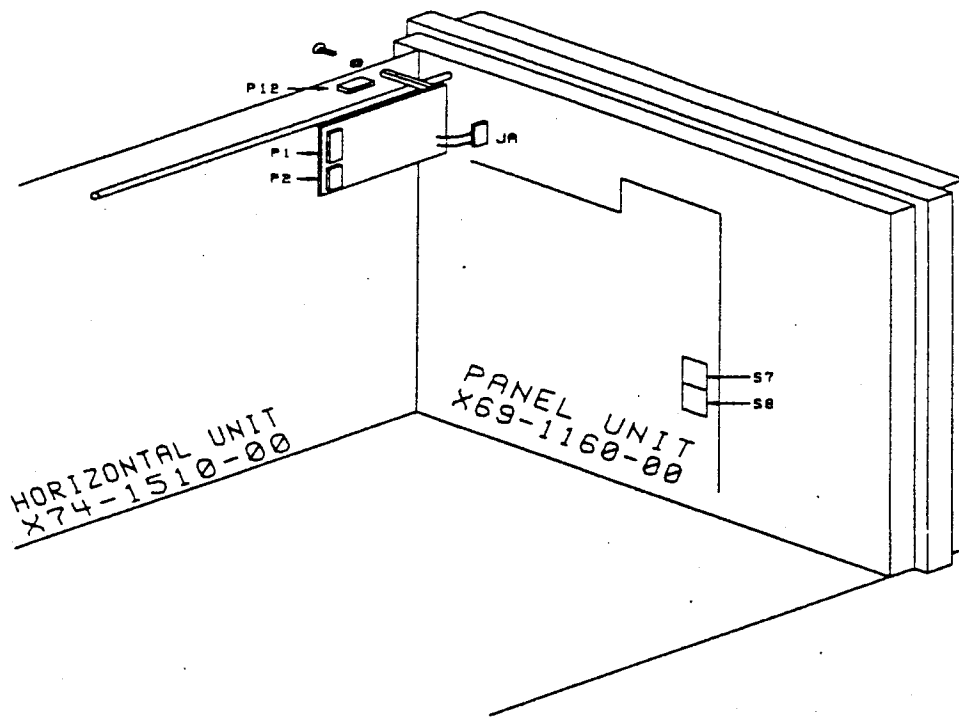
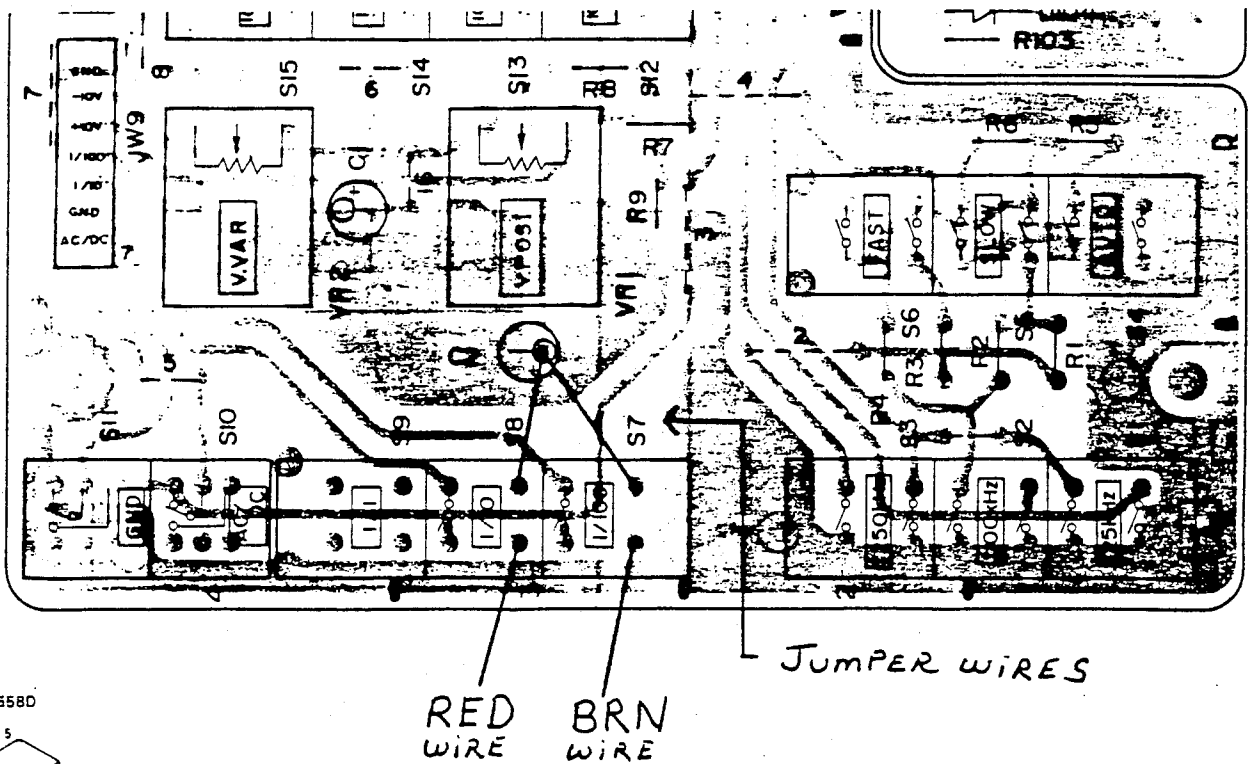

FIGURE 1



PANEL UNIT (X69-1160-00) FOIL SIDE VIEW

FIGURE 2

KENWOOD

SB-975

SERVICE BULLETIN AMATEUR RADIO

SUBJECT SM-230 RTTY CROSS PATTERN ATTENUATION	DATE 08/08/90
--	------------------

Some users of the SM-230 have reported that the MARK and SPACE gain adjustments do not sufficiently reduce the signals to display them on the CRT. The following modification will correct this condition.

REQUIRED PARTS:

680 OHM 1/8W RESISTOR RD14CB2B681J QTY. 2

1. Disconnect the power cord and control cables.
2. Remove the top cover (6 screws).
3. Locate the Horizontal unit. This board is vertically mounted on the right side of the SM-230.
4. Locate resistors R318 and R322 on the Horizontal unit.
5. Replace R318 and R322 with 680 ohm resistors.
6. Assemble the SM-230.
7. Adjust the MARK and SPACE gain adjustments as necessary to obtain the correct cross pattern.

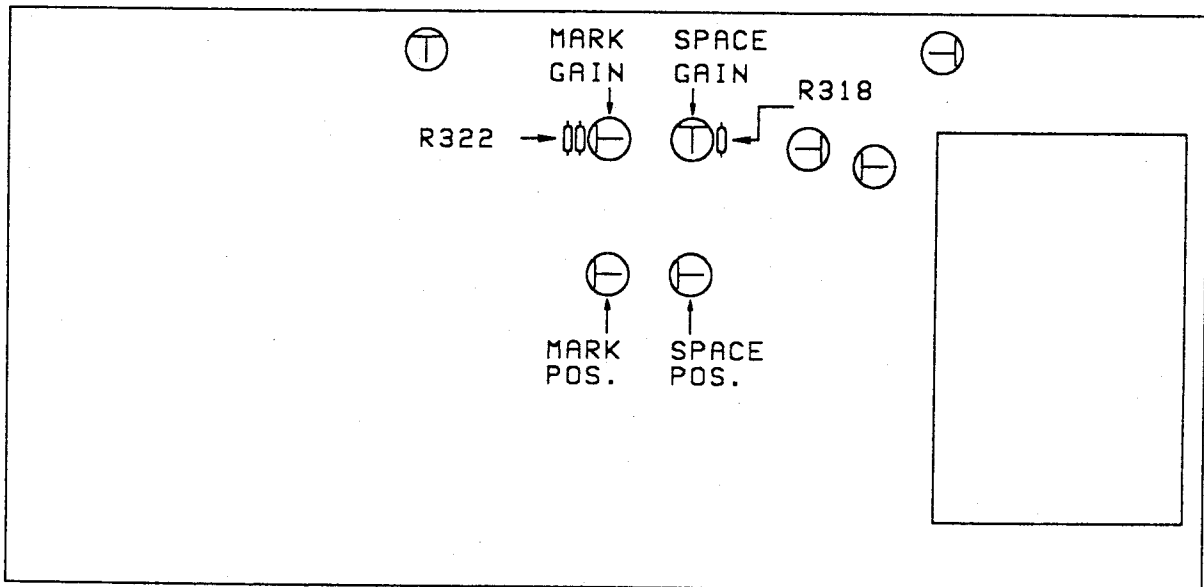

Time required to perform this modification is 1 hr. or less.
Copyright (C) 073190EWP for Kenwood U.S.A. Corporation.

KENWOOD

APU-0008

Publication Update

Amateur Radio Division

Subject: SM-230 Service Manual

Date: January 13, 1993

The part numbers for item number 12 and 14 are incorrect in the exploded view provided on page number 15 of the service manual (B51-8027-00 ©1989-9). Please make the changes noted below to the **EXPLODED VIEW** on page number 15 of this manual. The part numbers listed in the **PARTS LIST** on pages 7 and 8 of this manual are correct and do not need to be changed.

